

What Is in the New Grand Prix Eight Tube Super-Heterodyne? See Page 17; New and Improved Advance Program Listing Plan; Radio Football Schedules

Radio Digest

EVERY WEEK **Illustrated** PROGRAMS **TEN CENTS**

REG. U. S. PAT. OFF. & DOM. OF CANADA

Vol. XV

Copyright 1925
By Radio Digest Publishing Co.

SATURDAY, OCTOBER 24, 1925

No. 3

PLANS FOR BETTER RADIO

MEETING TO SETTLE PROBLEMS OF RADIO

HOOVER CONFERENCE WILL BE ALL INCLUSIVE MEET

Representatives From All Branches of Industry Invited to Confer With Secretary of Commerce

WASHINGTON, D. C.—Every problem presenting itself to any one in any branch of Radio will be threshed out at the fourth annual Radio conference called by Secretary of Commerce Hoover to be held here, beginning November 9. Representatives from all concerns and organizations interested have been invited by Mr. Hoover to attend and participate.

The three previous conferences solved many of the problems which embarrassed Radio communication and contributed greatly to its rapid progress. New questions now confront us and require consideration.

The conference is called for general discussion and consideration of matters affecting Radio communication in the United States from the viewpoint of the public interest. The conference will include representatives of all Radio activi-

(Continued on page 2)



Left, Ruth Pushin, exclusive Post-Wurlitzer star, sings every other Monday night from W K B C. Right, Viola Verdon, soprano, often delights the many WEBJ auditors.

LEADERS LIST POINTS TO AID BROADCASTS

Predict Future of Art

Radio Digest Begins Publication of Series of Opinions on "How to Improve"

Outstanding in their importance are a number of topics to be discussed at the fourth national Radio conference, called for November 9 by Secretary Herbert Hoover. "What's wrong with broadcasting?" and "How can we improve Radio?" are two questions which Radio Digest, by way of helping pave the way for an intelligent and comprehensive conference, has asked the prominent leaders of Radio and high officials interested in the destiny of the ether art. Readers will be interested in this series which starts in this issue.

First to answer the suggested questions, and complete in his analysis, is Martin P.

(Continued on page 2)



BILLY B. VAN TELLS HIS SUNSHINE TALKS

NEW YORK.—Thousands of people who have heard Billy B. Van on the stage have been aided by his humorous philosophy. Now Radio fans will receive inspiration to banish the "blues" for he is giving his series of "Sunshine Talks" from Station WHN, New York. Billy has been voted "The Greatest Radio Fan on the American Stage." His story, "The Seriousness of Being Funny," is a recognized classic.

Radio Speed Theme Is Motif for New Studio

WLS to Have First Distinct American Decoration

CHICAGO.—"Radio Art," an adaption of the decorative idea to express broadcasting, is to be supplied to the new studio of WLS now being completed in the Hotel Sherman by Alphonse Ianelli, one of the country's most noted designers.

Radio speed will be the theme of decoration. Everything will give the impression of motion; the walls, ceilings and even the furniture. "This is the first time a distinctly American treatment of decoration will have been attempted in any Radio studio in the United States," says Mr. Ianelli. He interprets Radio to fit a decorative scheme portraying modern times. The decorative plan of other studios heretofore has been to represent some particularly famous foreign room. WLS will be the pioneer in a startling American type of decoration.



Bebe Payne, right, heard from WEBJ, WGN, WMAQ and KYW, has nine avocations and many "publics." She is a vaudeville headliner, classic dancer, favorite in the dine-and-dance places and also in the Balaban & Katz productions, a violinist, artists' model, sculptor, and interior decorator.

How Can We Improve Radio Broadcasting?

THE following discussion, prepared by Martin P. Rice, manager of broadcasting for the General Electric company, is in answer to topics suggested by Radio Digest to a number of leaders of the broadcasting field. The suggested questions sent to these leaders are given elsewhere on this page. Mr. Rice's analysis of "What's Wrong with Broadcasting" and "How Can We Improve Radio" is to the point and of such importance that every Radio devotee should read it. The paper is presented herewith:

By Martin P. Rice, Manager of Broadcasting, of the General Electric Company



Martin P. Rice

1. THE small station properly equipped with apparatus and technical staff for maintaining good quality should continue because it serves a useful purpose in reflecting local community life, and it can occasionally be linked with other stations to assist in national broadcasting.

Daylight broadcasting will become more important as it becomes more reliable and the range of stations is extended by higher power and a better understanding of the laws of propagation.

Relay night broadcasting may be a feature in the future, but relaying has the disadvantage of reproducing extraneous disturbances and interferences as well as signals. Superpower stations may reduce the demand for relaying, but will never eliminate it unless the range of a superpower station can be made world-wide.

The small station, as has been stated, should continue, and program competition should not force it off the air because it will always have available matter of local interest which cannot be had from the large stations. The smaller stations and, in fact, all stations may be assisted by a service organization similar to the press associations in the newspaper field.

2. BROADCASTING programs in the future will include distinctive features in music, education, entertainment, dramatic art, news, and religion which cannot be obtained in other ways. In other words, the available air channels will become too important to permit clogging with routine matter. All studio programs should be built on this basis; they should not be mere reproductions from the theater or music hall—they should be Radio programs designed for broadcasting conditions and the Radio audience.

Programs will continue to be appreciated on their merits regardless of how or what the artists are paid.

State or federal censorship of Radio programs should be unnecessary, and it would be a reflection on the good sense of broadcasters if the public should urge it.

3. THE desire to broadcast will necessitate some plan by which time on the air may be purchased under suitable conditions and regulations, and the toll station may be a partial answer to the question, "Who is to pay for broadcasting?"

Under paragraph 3 you say, "We must consider that large business enterprises who operate their own stations, are really doing toll advertising on an exclusive scale unless these big firms allow a certain part of their time on the air to be leased by other firms or individuals." This statement overlooks the fact that several of the large stations today are operated in the interest of the development of the Radio art and for the expressed purpose of maintaining a standard in broadcasting so that purchasers of receiving sets will not be disappointed.

There is no reason to suppose that superpower or any other influence will exterminate all except the toll stations.

The support of broadcasting by a tax on Radio manufacturers by mutual agreement might offer a logical method of supporting broadcasting, and would undoubtedly be far more acceptable than a license fee on receiving sets collected from the public. Broadcasting has developed more rapidly in America under the free system than in any other country, and its growth should not be checked by an objectionable tax.

4. SOME plan of limiting the number of licensed broadcasting stations must be adopted because the number of stations which can be operated successfully is necessarily limited. The plan should take into consideration such factors as location, priority, and ability to serve. In other words, the public good should be the chief consideration in licensing a station.

5. BROADCASTING should remain under the control of the department of commerce which I assume has power to appoint such advisory committees or boards as may be needed to assist in its administrative work.

merce should be given discretionary power in the granting of licenses for broadcasting stations and the general regulation of broadcasting.

7. IF the Radio section of the department of commerce has not sufficient funds to carry on its work, its needs should be tabulated in budget form and an appropriation requested.

8. THE department of commerce should require broadcasting stations to maintain accurately and absolutely the assigned frequency, but it would be inadvisable for the department to prescribe the specific method by which frequency is to be maintained.

9. INTERNATIONAL superpower broadcasting has not yet developed sufficient reliability to become a part of the daily program, and we would therefore not be warranted in allocating to it a group of wave bands. However, it would be highly desirable to avoid the duplication of wave lengths assigned to high-power stations broadcasting programs of national and perhaps international interest over wide ranges.

QUERY RADIO LEADERS

(Continued from page 1)

Rice, manager of broadcasting for the General Electric company, an organization which has invested millions of dollars in the development of the art and science of broadcasting.

His discussion will be found herewith. Among the topics he discusses are:

What's to become of the small station? For where are programs headed? Who's to pay for programs? Shall broadcasters be limited in number? Should Secretary

6. NEW or amended Radio legislation is needed, because the present laws were enacted before the development of broadcasting. The department of com-

CONTENTS

Radio Digest, Illustrated, Volume XV, Number 3, published Chicago, Illinois, October 24, 1925. Published weekly by Radio Digest Publishing Company, 510 N. Dearborn Street, Chicago, Illinois. Subscription rates, yearly, Five Dollars; Foreign Postage One Dollar additional; single copies Ten Cents. Entered as second class matter at the post office at Chicago, Illinois, under the Act of March 3, 1879.

Table listing contents: All the Live News of Radio (1 to 7), WHAD, the Newspaper-College Station (5), Advance Programs for the Week (8 to 14), An Evening at Home with the Listener In, a chart in eastern time, showing when to listen in for your favorite stations (14), Following Sports Through Mike (15), Editorials, Indi-Gest and Condensed by Dielectric (16), The Grand Prix Eight-Tube Super-Heterodyne, Part I—What Is in It and Why, by James McDonald (17), "Traveler" Doughnut Coil Tuned R.F. Receiver, Part III—Complete Wiring Instructions, by John G. Ryan (19), A. B. C. Course in Radio Fundamentals, Chapter XXXI—Modulation in Radiotelephony (Conclusion), by David Penn Moreton (21), Questions and Answers (22), Directory of Radiophone Broadcasting Stations, Part IV (23)

Looking Ahead

"How Can We Improve Broadcasting?" which starts this week with the views of Mr. Rice of the General Electric company, will continue in the future with more articles by the men who are in a position to know what is wrong and how steps should be taken along the road to perfection.

Many Station and Artist Feature Pages next week will take you all into the inside workings of the Radio studios. WHT, where Pat Barnes holds forth at the mike, will be described. Save a place in your albums for the many pictures of well-known stars which will appear.

"Interesting and Simple Explanation of Radio," is the very fitting title of a new series of articles for the newcomer who is either just building his first receiver or has recently purchased one and would like to know something of the invisible action behind it all. The first article will appear in the next issue. Prof. H. G. Tanner, of the University of Oregon, is the author.

The Drilling and Assembly of the Grand Prix Super-Heterodyne will be taken up in the second article of the series starting this issue by James McDonald. With the exact parts specified and the location of every hole given, no builder should have any trouble with this compact, good-looking outfit.

Adjusting and Operating the Traveler Tuned R.F. Receiver forms the fourth article of the series of John G. Ryan. Those who have constructed this set but are not sure of the battery connections nor how to tune for best results, get all this information next week.

Newsstands Don't Always Have One Left

WHEN YOU WANT

Radio Digest

YOU WANT IT!

BE SURE OF YOUR WEEKLY COPY BY SUBSCRIBING NOW

SEND IN THE BLANK TODAY

Form for subscription: Publisher Radio Digest, 510 N. Dearborn St., Chicago, Illinois. Please find enclosed check M. O. for Five Dollars (Six, Foreign) for One Year's Subscription to Radio Digest, Illustrated. Fields for Name, Address, City, State.

SUGGESTED QUESTIONS

- 1. What is the future of the small station? Daylight broadcasting? Relay night broadcasting? Or will that be unnecessary on account of the superpower stations? Will the small station be forced off the air by program competition?
2. What type of programs (include various classes) are destined for the future? Of entertainment programs, what kind would you consider the best? What of the "continuity" or "presentation" program? Are you opposed to state and federal censorship of Radio programs? Why?
3. Will toll stations be the answer to "Who's to pay?" We must consider that large business enterprises, who operate their own stations, are really doing toll advertising on an exclusive scale, unless these big firms allow a certain part of their time on the air to be leased by other firms or individuals. Will superpower growth cause the toll station to be the sole survivor of the American system? What about taxing Radio manufacturers, or by a public receiving license fee as in England?
4. Shall broadcasting stations be limited in number by some licensing plan based on priority and ability to serve, or some similar device? The Kintner plan has been proposed as a means of limitation. What is your opinion of this plan?
5. Do you favor appointment of an unbiased, non-partisan broadcasting control board, in which the public, the broadcasters, the Radio industry and the government shall be represented, which board shall have the power vested to settle all differences pertaining to broadcasting and the interpretation of present or future Radio legislation? How should such a board be appointed? Define the board's power.
6. Do we need new or amended Radio legislation? What should this include?
7. The Radio section of the department of commerce last year was given \$125,000 with which to work. The department, according to an estimate, employs 70 persons. Trips of supervisors and their assistants all over the country must come out of this appropriation as well as the 70 salaries. No money is left for instruments—the most necessary equipment for the supervisor. Does the department need more money? If the government wishes to reduce taxes, why not apportion the inspection costs wholly or partly to the various stations?
8. The piezo-electric crystal is an unwavering guide which holds a station on its assigned frequency. Why not adopt it as requisite of every broadcasting licensee? The bureau of standards could test each one to see that it was ground to the exact licensed frequency, and the cost—not large, being well under one hundred dollars—could be borne by each station. If not each station, why not make it a requisite of every station having a power exceeding 250 watts?
9. What do you think of allocating certain wave bands to international superpower broadcasting and reception?

Hoover be assisted by a broadcasting control board in administrating Radio? Do we need new Radio legislation? Shall we appropriate more funds for the Radio supervisors? Why not adopt the Piezo electric crystal to keep stations on their wave? What about allocating certain wave bands to foreign and American international broadcasters?

OUTLINE RADIO CONFAB

(Continued from page 1)

Representation will be accorded to members of the following groups, one to each concern falling within any of them:

Broadcasting stations; Radio magazines; newspapers having a Radio department; manufacturers of complete Radio receiving sets; organizations of broadcast listeners; amateur organizations; commercial land Radio stations; Radio trade associations; press associations; United States government departments.

Others to Be Represented

Representation will also be accorded the following:

Institute of Radio Engineers, American Institute of Electrical Engineers, American Steamship Owners association, United States shipping board, farm organizations and National Electric Light association.

In order that proper arrangements may be made for the accommodation of the conference, it is essential that concerns or persons desiring to participate in the conference advise the secretary of commerce on or before October 26, 1925, giving the names of their representatives.

This notice constitutes an invitation to all concerns and individuals falling within any of the classes mentioned.

Broadcasting Problems Greatest

While consideration will be given to Radio activities generally, the principal problems will be those affecting broadcasting. The subjects, so far as they can be outlined at present, will be:

Recognition of the principle that service to the listening public must be the basis for every broadcasting privilege and for all Radio regulations; the present saturation in broadcasting due to the exhaustion of channels, and the necessity for limiting the number of stations on the basis of public service; the requiring of permits in advance of construction of broadcasting stations; the necessity for operators' licenses, particularly for broadcasting stations; frequency band assignments for the various classes of Radio communication; the use of high power for broadcasting; the location of broadcasting stations so as to prevent interference in congested centers; time division, duplication of frequency and assignments, and a geographical basis for allocations; the use of broadcasting for advertising; matters affecting amateurs; matters affecting the marine and mobile services; rebroadcasting.

Meetings of the conference will be open to the public and opportunity will be afforded for the expression of views upon any of the subjects above outlined.

RADIO BRIDGE HANDS NEW CHAIN FEATURE

EXPERTS TO PLAY SAMPLE DEAL TO INSTRUCT FANS

Play-by-Play Description of Popular Card Game Will Enable Many to Learn

NEW YORK.—Bridge by Radio, the latest innovation, to be inaugurated by WEAJ and associate stations for a regular Tuesday night feature for this fall and winter starting on Tuesday, October 27, at 10 p. m., eastern time. The stations on the network that will broadcast these bridge hands every other week are WSAI, Cincinnati, Ohio; WEEI, Boston, Mass.; WFI, Philadelphia, Pa.; WGR, Buffalo, N. Y.; WWJ, Detroit, Mich.; WCCO, St. Paul-Minneapolis, Minn., and WOC, Davenport, Iowa.

The first play will take place with Milton C. Work, Wilbur C. Whitehead, E. V. Shepard and Sidney Lenz, internationally known bridge authorities, as the participants, on the evening of October 27.

Fans Can Play Too

The plan is to have four experts play a deal of auction bridge and to broadcast each bid and each play of the deal, together with the reasons for each bid and each play. Prior to each broadcasting, listeners in will be informed as to the names of the participants. On the game night any four may play, and each be named after one of the experts and take the same relative position at the table. The players will be told to have a pack of cards divided into suits, so that the cards as they are dealt and broadcast may be quickly selected from the pack. The result of the draw for partners and deal will be announced, and then the cards dealt to each expert. The bidding will then follow, after which each play will be announced so that the players can play the same cards that the experts do.

It is apparent that four experts might play a dozen deals before one would be reached that would be worth broadcasting, consequently, it was necessary to select in advance the twenty-four deals that will be broadcast. The selection of these deals was of the utmost importance as each must carry not only one but several bridge lessons, it being the intention in these twenty-four deals to cover all the important principles and conventions of bidding and playing; also, it was necessary that the leading players throughout the country be selected and invited to participate. The man who undertook this work was E. K. Leech, who is widely known in bridge circles. He examined hundreds of actual deals; he analyzed each deal selected before being played by the experts; and re-analyzed it after play, to be sure that the line of play adopted was fool-proof, or rather expert-proof.

Order of Broadcast

The account of each deal follows a regular order: First, the players; second, their positions; third, their cards; fourth, the bidding, with the reason for each bid; fifth, the play, with the reason for each play, and sixth, a resume of the more important features of the bidding and play. With these are interwoven instructions to the listeners in, together with explanations of certain rules and conventions that arise.

The games will illustrate: The original bid; the secondary bid; the take-out; the informatory double; the denial; the assist; the business double; the four-card suit bid; how to gain the best bid for the combined hands of partners; the correct opening lead; partner's response; the come-on signal; the down and out signal; the proper discard; when to take a finesse and when not to; the obligatory finesse; the obligatory duck; the squeeze play; the strip play; how to plan the play; deduction; the doctrine of chances; exit cards; throwing the lead, and practically all the other conventions and principles of the game.

Radio Is Blamed Whether There Is Weather or Not!

ATLANTA.—A perturbed Georgian recently appealed to Governor Clifford L. Walker to curtail WSB's activity on the ground that Radio was responsible for the prolonged drought prevailing in the southeast. The governor answered by pointing out that three years ago WSB had been charged with precipitating a heavy excess in rainfall.

Ten-Watter Heard by DX Ship

NEW ORLEANS.—What is believed to be a long distance record for a 10-watt station was established here when WOWL, the Owl Battery company plant, received word from a ship 700 miles at sea, west of San Francisco, that its program had been heard all over the craft.

OLD SALOON PIANO'S TUNE PROVES TRUE

THE reputation of WEAJ for fidelity of piano reproduction was humorously illustrated in connection with a recent program. A fan 'phoned that he had never heard such an atrocious piano and suggested calling in a piano tuner. Upon investigation, it was found that the piano was supposed to sound out of tune and tinnany, since it was used in the prologue to the feature picture in a scene depicting an Alaskan dance hall in the time of '98, such as described in the "Shooting of Dan McGrew."

BARBER SHOP CHORD RADIO CONTEST TUNE

HARTFORD, Conn.—A barber shop ballad championship contest has been announced by WTIC to take place some time this month. All male, female, and mixed quartets may enter the contest. It matters not whether they represent a club, lodge, school, college, or an actual barber shop. All are eligible if they can sing close harmony. Each quartet must sing three songs: "Sweet Adeline," "Mandy Lee," and a third of their own choosing. The decision will be left with the audience and three judges.

SHE WINS FAME IN AUDIO DRAMAS



Rose Brown, charming leading lady of the KGO Audio Players, is regularly cast in the extremely entertaining productions of the Pacific coast station of the General Electric company. Miss Brown's poise and beauty, while unnecessary for the Radio drama, are commented on by all who have the pleasure of seeing her.

New Stations

WLWL, the new 5,000-watt station of the Paulist league, is on the air. Programs are given on a wave length of 288.3 meters every Sunday, Tuesday and Friday nights.

Joliet, Ill., has a new 100-watt broadcaster, WKBB, owned by Sanders Brothers and operated on 214.2 meters. Charlotte, N. C., announces a new 10-watt transmitter, WJBG, Interstate Radio, Inc., 224 meters.

The following commercial class A stations were deleted last month: WJBD, Ashland, Wis.; WABI, Bangor, Maine; WGBL, Elyria, Ohio; KFLP, Cedar Rapids, Iowa; WSRF, Broadlands, Ill.; WGBA, Baltimore, Md.; KUPR, Omaha, Neb.; WSAV, Houston, Texas; KFAF, Denver, Colo.

WAFD, the 500-watt station at Port Huron, Mich., has been transferred from class A to B. This broadcaster, owned by Albert B. Parfet company, uses 275 meters.

Europe Has Interference Too

WASHINGTON, D. C.—American Radio fans who have always been given to understand that receiving conditions in Europe were ideal as compared to those in this country will be interested in learning that there is growing complaint about interference between various European stations. In view of the interference experienced in Sweden, experiments are now being conducted there with a view to eliminating the complaint.

ELECTRONS WHIZ AT SCHENECTADY

Listeners Hear Atom Decomposed —and It Only Requires 5,000,000,000 Years

SCHENECTADY, N. Y.—Electrons fired by a decomposing chemical element recently spoke to the audience of WGY. The listener was thus acquainted with a particle so small that countless millions of them could meet on a pin point and not be overcrowded.

The opportunity of listening to the electron was given during the first of four talks on the electron, its habits and uses, delivered Tuesday evening, October 13, by Prof. Peter I. Wold, head of the physics department of Union college, Schenectady.

The subjects of the talks to follow on Tuesday evening, October 27 and November 3, respectively, will be "Effect of Electron Discovery on Scientific Theories" and "Sources of Electrons and Their Practical Applications."

There are a few heavy elements which decay or go to pieces so fast that the process is measurable, can be made visible and, by the apparatus developed by the general electric scientists, can be made audible. This "speed" of decay is hardly speed in the accepted sense because the process in the case of a little piece of uranium would require 5,000,000,000 years to complete and at the end of that time the original piece of uranium would have lost but a fraction of its weight and left some metallic lead.

SILENT NIGHTS ARE MANY IN COLUMBUS

HIGH POWER DRIVES SMALL STATIONS FROM ETHER

Daylight Programs Increase as Local Broadcasters Turn from Nocturnal Schedules

By a Columbus Observer

EVOLUTION of better and more consistent broadcast programs, pushed into the air by high-powered stations in the larger cities, has brought about big changes in Columbus, Ohio, in recent months. Most significant of the changes is the almost total discontinuance of evening concerts from the local stations and a corresponding increase in the amount of material broadcast during daylight hours.

Two years ago Columbus ranked first in Ohio with five stations operating regularly. Now there are two stations which adhere to a regular daily schedule, one which comes on the air spasmodically, and another which is broadcasting only on Sundays, as it always has. The fifth station long ago sold out its equipment to a Dayton concern.

One by One They Die

Two years ago there were four or five evening concerts weekly from the local stations. Last winter the number was reduced to four. On October 2 Station WBAV of the Erner & Hopkins company broadcast its last routine evening concert, after previously discontinuing its bills on Monday evenings. At the same time the management of station WEAJ, the Ohio State university, announced its policy of having only one evening concert per week—on Wednesdays. This brings the total down to one, and university officials are not certain that they will continue to use Wednesday night.

WCAH, the Entrekin station, comes on the air only when something special turns up, and its activity mostly has been confined to commercial programs.

The Reason Why

The reason for all this? It was simply a matter of not being able to compete with the larger and more powerful stations throughout the country. Local and central Ohio listeners evinced little interest in the Columbus programs. Indeed, some of them waxed wrathful because of alleged "interference," regardless of the class of music broadcast.

In such a situation the station managers did the obvious thing. They got out of the air at night and let the fans listen to distant stations to their hearts' content.

Daylight Features Increase

Radio fans in other parts of the country will have to listen for Columbus stations during daylight hours and up to 7 p. m., eastern standard time, daily, except on Wednesdays when WEAJ is on the air until about 10 p. m. With the decrease in evening concert music, stations WBAV and WEAJ have increased their daylight music and features. Their present schedules are as follows:

WBAV—12 noon daily, except Sunday; 6 p. m., dinner music, Monday, Wednesday and Friday.

WEAJ—9:45 and 11 a. m., 1 p. m., daily except Sunday; 4 p. m. daily, except Saturday and Sunday; 8 p. m., Wednesday. Early evening programs being considered.

'The Bootleggers Own' New Orchestra's Name

WAHG Jazz Music Is Unconscious Aid to Smugglers

RICHMOND HILL, N. Y.—"The Bootleggers Own" is the new name unofficially given to Glenn C. Smith's orchestra at the Grebe Station WAHG here, due to their inadvertently aiding a group of run runners off the Jersey coast in disguising their illegal craft and thus failing the efforts of the revenue officers to stop the liquor leak.

According to three of the gentlemen engaged in the relief of the thirsty, signing themselves Canada Redtop, Toledo Slim and Brunswick Bill to a letter to Mr. Smith, they catch the orchestral jazz on their Radio set and sail into the creeks and bays with their cargoes. The coast guard officers, hearing the music from the loud speaker, think the liquor craft to be a harmless pleasure boat and do not molest it. And next day the quotations on Scotch fall, due to a flooded market.

Merchants Save Charlotte Radio

CHARLOTTE, N. C.—In order to enable the owner to keep Radio Station WBT here, local merchants purchased time for broadcasting advertising programs and thus have made the plant a real civic institution. Almost all the available time has been sold, but it is announced that this will not interfere with the regular programs.

NEWS BRIEFS FROM THE BROADCASTERS

FANS BREAK MAIL RECORDS FOR OPERA STARS AT KGO

WEAR Entertainer Stops Cleveland Show; Isaac Walton League Meets at KDKA

The greatest volume of mail ever received at KGO from a single broadcast is pouring into the station from all points of the compass as a result of the recent concert of Victor artists, during which Tito Schipa and Marcel Journet, grand opera stars, and an orchestra selected from the personnel of the San Francisco symphony gave an hour of music.

History was made at the Park theater, Cleveland, Sunday evening, during the WEAR broadcasting of the musical program when Jimmy Ague, "One of the Boys from Songland" and a regular WEAR entertainer, "stopped the show." This is distinctly a triumph for Radio.

Radio chapter No. 1 of the Isaac Walton League held its first monthly meeting from KDKA on Saturday evening, October 17, and will meet on the third Saturday evening of each month thereafter.

A series of "impressions" arranged by Otto F. Beck, organist of Crandall's Tivoli theater, are being featured in his Tuesday recitals from WRC during the fall and winter. By using many of the unusual stops on the organ, Mr. Beck has made popular his interpretations of such themes as "A German Street Band," "The Whistler and His Dog" and "Four Scotch Pipers."

To mark the national holiday, October 12, Albert Ulmann spoke from WEAF at 7:00 p. m., eastern time, under the auspices of the New York Historical society on "Christopher Columbus."

With the special Columbus Day program from WEAF and WOO, the Plunketeers signed off their regular Monday night programs.

Alvin Roehr's music makers will be a regular nightly attraction this winter from WKRC, the Kodel Radio corporation, Cincinnati.

Wallace Bruce Amsbarry, well known as an author, poet and orator, is giving readings, with incidental music by the WLS trio, of the best poets, twice a week at WLS, Chicago. Sunday, October 25, he will read "Waiting" by John Burroughs and "There Is No Death," by J. L. McCreary. This following Wednesday, at 8 p. m., central time the program commemorates Frank L. Stanton, the "Singer of the Southland."

Olaf Bernts, consul for Norway, supervised the classical Norwegian program given recently at WBBM, Chicago. This program was the second of the "Know the World" series. Emil Biorn, arranged the musical selections. Lilly Grinsgaard, a noted actress from Oslo, and the Norwegian male quartet were featured.

"The Wickedest Girl in the World" was the title of a talk broadcast from WOR recently by Eleanore Browne, whose stories of drama and romance hidden away in Europe's underworld and also its high world have thrilled newspaper readers during the last year. The occasion is Miss Browne's Radio debut.

Music from "Scheherezade," famous symphonic suite of Rimsky-Korsakoff, who is credited by musicians with being more distinctive and individual than any other Russian composer, will be played by the KGO Little Symphony orchestra, Sunday afternoon, October 25, at 3:30 p. m., pacific time. Something of the life and work of Rimsky-Korsakoff, together with a brief description of the "Scheherezade" music will be told by Arthur S. Garbett.

Radarios or Radio plays are again featured at WLW, Cincinnati. "The Valiant" is scheduled for Saturday night, October 24, at 8 p. m. central time.

The autographed photographs of the first three Pooley artists are now ready for distribution. These include Waino Kauppi, cornetist of the Goldman band; Clyde Doerr, saxophonist and Stefano di Stefano, the concert harpist and soloist at Grace church. These pictures may be obtained by writing the Pooley company, Philadelphia, Pa., WEAF or the station through which the program was heard.

The spinet upon which is played the old English and French music of the "Waterman's Points of Progress" hours broadcast each Wednesday evening, from WEAF and chain, is a genuine reproduc-

tion of the spinet used in 1520. It was built in 1910 by Arnold Dolmetsch in Boston. The original instrument derived its name from its inventor, Spinetti of Venice, Italy. It was of oblong shape and had one string to each note.

The Arts club, Buffalo, N. Y., composed of musicians and artists, is scheduled to give six concerts throughout the coming months over WGR. The dates of the first four are: November 20, December 7, January 1 and February 15. Jan Walonek, famous violinist, will be in charge.

"Jewett Jesters" are appearing in public, as well as broadcasting, each Sunday night, from 8:30 to 10:30 p. m. eastern time, at Orchestra hall, Detroit, for the purpose of acquainting Radio listeners with performers whose personalities they have become acquainted with over the Radio. The stage of Orchestra hall will be converted into a replica of WJR's studios in the Book-Cadillac hotel.

The Sleepy Hollow trio will give a concert, Thursday, October 29, at KDKA. The trio received its name from the song,

"The Sleepy Hollow Tune," composed by Richard Kountz, a Pittsburgh composer and pianist of the group.

KMA, Shenandoah, Iowa, also has some "How-do-you-do" boys who have the mysterious nom de plumes Jonathan and Ben Davis.

Ford and Glenn, the Lullaby Boys of WLS, Chicago, with Announcer George D. Hay and Ralph Emerson, WLS organist, are finishing up a two weeks' visit at Dallas, Texas, where they are broadcasting over WFAA and appearing at the Texas state fair.

Equip Eye Hospital with Sets

LONDON, Eng.—The Radio installation of the Royal London Ophthalmic hospital, the first English hospital to be fitted with a complete equipment by means of the special fund raised for the purpose, has been formally inaugurated by the lord mayor. As the patients suffer from eye defects, the treatment of which involves them in complete or partial darkness, it was fitting that complete Radio equipment be installed.

"RIM OF THE WORLD" PLANS REBROADCAST

Mountain Station Will Pick-Up Eastern and Central Stations

BIG BEAR LAKE, Calif.—Bertram O. Heller, owner of the "Rim of the World Superstation" KFXB, is planning on re-broadcasting the programs of not more than twenty-four eastern and middle western stations from this spot 6,800 feet above sea level. He is now soliciting the consent of the stations he has selected to help get over the mountains.

The location of KFXB is such that it is possible to receive there, with the average set, almost any station in the United States. This excellent reception and the rebroadcast will enable fans on the coast to receive the eastern stations much better than ever before. Among the stations which have been asked for rebroadcasting permission by Mr. Heller is KTHS, Hot Springs National Park, Ark.

KFXB is temporarily operating on 202.6 meters and 500-watts.

ATWATER KENT RADIO

"Never seen 'er do that before!"

A farmer in Vermont was trying to sell his ancient mare as a spirited animal. He led her from the stable and was starting to put her through her paces, when suddenly she lay down, rolled over and died. The farmer was somewhat taken aback. "Well, well," he said. "Never seen 'er do that before!"

UNFORTUNATELY there are radio receiving sets which bear a close resemblance to the old mare. They can often go through their paces. But at any time they are apt to need first-aid badly.

When you buy your radio, whether it is your first or your tenth, take this advice:

Look at it carefully, inside and out. See whether or not it looks to you like a clean, workmanlike job.

Hear it in operation. Then ask your

dealer about the manufacturer. How long has he been in business? What is his reputation?

Do his sets need a lot of service after they are sold?

On a judgment of that sort, Atwater Kent is willing to stand or fall.

Send for illustrated booklet telling the complete story of Atwater Kent Radio

ATWATER KENT MANUFACTURING CO.
A. Atwater Kent, President
4708 WISSAHICKON AVENUE PHILADELPHIA, PA.

Hear the Atwater Kent Radio Hour every Sunday evening at 9:15 o'clock (Eastern Standard Time) through stations:

- WEAF New York
- WJAR Providence
- WEEI Boston
- WFI Philadelphia
- WSAI Cincinnati
- WGR Buffalo
- WCAE Pittsburgh
- WWJ Detroit
- WOC Davenport
- WCCO Minneapolis-St. Paul

Radio Speakers \$12 to \$28



Prices slightly higher from the Rockies west, and in Canada.



Model 20, \$30

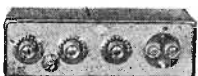

Model 20 Compact, \$30



Model 10 (without tubes), \$30

WHAD, the Newspaper-College Station



This studio of WHAD is the smaller of the two in science hall, at the Marquette university. Other studios and remote control centers are located elsewhere in Milwaukee.



Left, Arthur Richter who plays during the evening hour of organ music at Saxe's Wisconsin theater. Right, Edmund Fitch who plays requests during the Wednesday midnight organ recital.



R. J. (Bobby) Sine, "Solo orchestra." A feature of the Journal "Family at Home" program of WHAD.

WHAD is the result of a cooperative arrangement between one of Wisconsin's leading educational institutions, Marquette university, Milwaukee, and Wisconsin's leading newspaper, The Milwaukee Journal. The transmitting station is located in the new science building of the university, and the technical staff of the station is furnished by the university. The Journal organized and mans the remote control stations, arranges programs, and promotes new ventures.

The university and the newspaper joined forces in January last, putting on the air Wisconsin's first 500-watt Radio broadcasting station. Broadcasting is now done from four strategical points in the city, not including broadcasting of Wednesday night and Sunday afternoon open air concerts by the city's park board band in Washington park, a summer feature. Marquette broadcasts a Monday evening studio program. The university has two studios, one in the tower of the science hall near the operating room, and the other on the second floor of the building where larger gatherings of artists may be accommodated.

The most important of the remote control stations is at Saxe's Wisconsin theater, the biggest theater in the state, at which 21 microphone placements have been stationed. From this remote control there are regularly broadcast an evening hour organ music on Wednesday, Friday and Saturday; a midnight request organ recital on Wednesday from 11:30 to 12:30 p. m.; a two-hour dance program from 8:00 to 10:00 p. m. from the two orchestras on the Wisconsin Roof, and a studio revue, comprising the best talent available from the various Saxe theaters throughout the city on Friday from 8:00 to 10:00 p. m.

Another remote control has been placed at the Milwaukee Athletic club with five microphone placements, from which there is broadcast on Monday, Tuesday and Thursday, except during the summer months, an hour of evening dinner music by Bill Benning and his orchestra, and various studio programs on the same evenings during the intermission of the orchestra. Special arrangements at the Milwaukee Athletic club permit the broadcasting of any banquet or entertainment which might be held in any of the dining rooms or private rooms.

Another remote control has recently been installed in the new \$2,000,000 home of The Milwaukee Journal, to permit
(Continued on page 6)

One remote control studio is in the \$2,000,000 new Journal building.

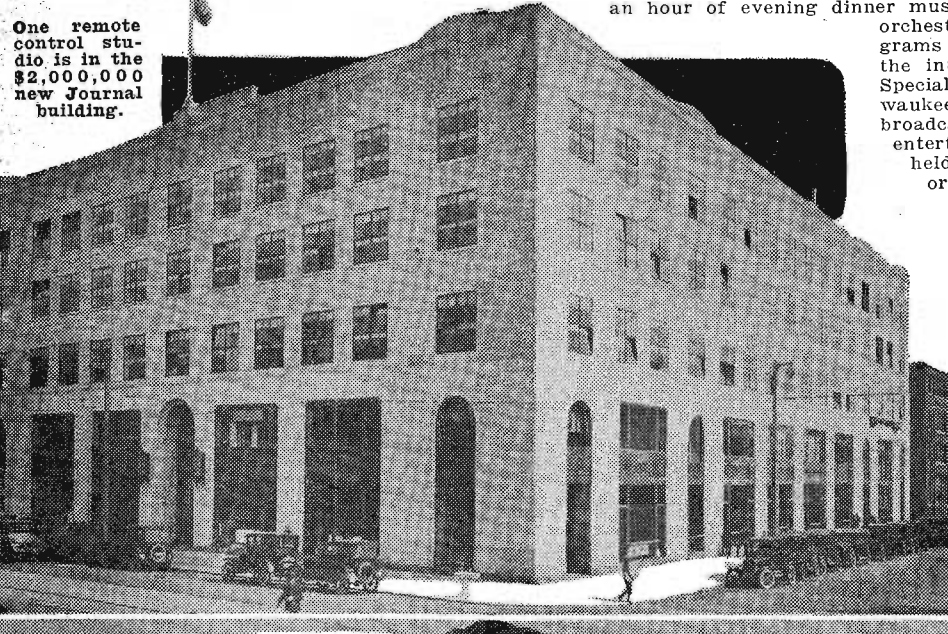

Above, Baby Mona, eight-year-old soprano on children's programs. Right, Louise Aldrich, accompanist.



Left, R. E. Knoff, B. C. L., Journal announcer at remote control stations and Chief Operator Wareing.

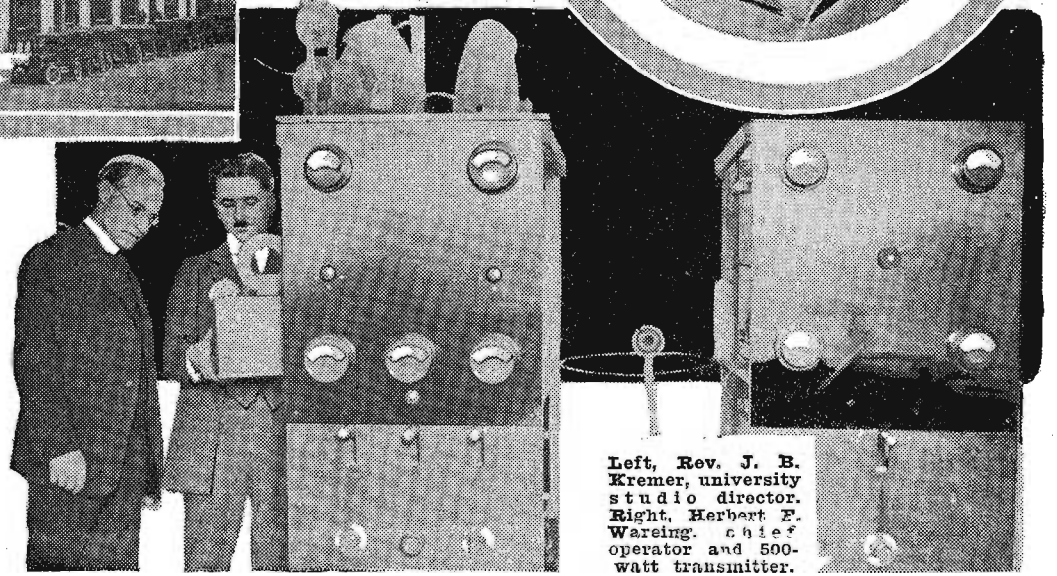

Left, Rev. J. B. Kremer, university studio director. Right, Herbert F. Wareing, chief operator and 500-watt transmitter.

AD BUREAU EXPOSES NEW RADIO SHARPER

VORTKAMP ABUSES TRUST OF STATION MANAGERS

Better Business Group Warns Against Unethical Methods of Broadcast "Gyp" Merchant

NEW YORK.—A warning sent out by the better business bureau of the Associated Advertising Clubs of America to all broadcasting stations warning them of the methods of doing business of one Henry F. Vortkamp might be of interest to the fans as well.

It seems that Vortkamp appears at various broadcasting plants where he passes off as a Radio expert on a vacation and offers to make a short talk on Radio. His speech, submitted to the announcer before being put on the air, is in itself harmless and more or less interesting. At the conclusion of it he announces that he will send a free copy of a special hook-up for a one tube set to all writing him. When the letters are answered this man incloses the diagram which takes up a fraction of one side of a letter. The balance of this side is covered by his own series of advertisement which he has sold to manufacturers.

He Abuses Privileges

On the reverse side he prints a come-on letter which tells the listeners that he has made special arrangements to sell them this set for a stated price.

"It is clearly evident," the bulletin says, "that Vortkamp has abused the privileges accorded him. Instead of merely delivering a lecture of general interest to the Radio fans, he has promoted his own financial ends, without disclosing that fact to the station managers."

"Because we believe station managers will be interested in protecting the good name of their studios, this report is given to all concerned for their information and guidance."

North Alabama to Have Plant

DECATUR, Ala.—The first Radio broadcasting station in north Alabama will be opened here at an early date, according to plans of J. W. Woodall, owner of the Woodall Electric company.

WRR, NEW IN SET, IS GENUINE OLD TIMER

WRR—Who is that? Don't you know? It's the municipal station, WRR, of Dallas, Texas, all fixed up with a new 500-watt, 101B Western Electric transmitter.



Dr. D. V. Wilson

The occasion for special interest on WRR's coming back on the air, lies in the fact that WRR was undoubtedly the first municipally owned and operated station in the United States. It started in away back four years or more ago with a set which, while good, finally became too old to be satisfactory.

Have you heard WRR since October 10 when the new set raised its voice in dedication?

"The City of Achievement" is its slogan.

Dr. Dudley Victor Wilson, formerly "Vic" at WFAA, Dallas News and Journal, is supervisor. He knows broadcasting, having served as both operator and announcer previously.

John Thorwald, who has a rich, baritone voice and is a music teacher in Dallas, is announcer. He has been heard singing and assisting at announcing from WFAA. Enthusiastic lady fans will enjoy learning that he is also unmarried and very eligible.



John Thorwald

W. J. Reid is program director of the municipal enterprise, and Grimes Waller is station operator. L. B. Henson, supervisor of WFAA, who directed the building of the first WRR set, directed the installation of the new equipment.

WRR is operated by a board of control composed of James E. Forrest, chairman; Louis Turley, E. J. Kiest, Harry Beeler and W. J. Reid.

WHAD IN MILWAUKEE

(Continued from page 5)

broadcasting news and daily talks by specialists on the staff.

Department editors and special writers on the staff of the Journal now broadcast daily concise comment on the news and current topics in the form of Radio editorials. At the same time persons on the Journal staff discuss, briefly and simply, such topics as the latest books, questions of investment, practical golf, boxing, nature study, gardening, Radio and problems of the housewife. Day time "service schedules"—a period of fifteen minutes at 11 a. m. and 30 minutes at 4 p. m.—have also been added to the schedule of WHAD.

Station WHAD operates on 500 watts at 275 meters. The present equipment is such that 750 watts are available immediately and 1,000 watts can be had with slight changes.

WHAD has been heard as far as Tahiti, 6,600 miles from Milwaukee. Appreciation cards have been received from every state in the United States, Canada, Mexico and many foreign countries.

The policy of WHAD does not permit the announcement of any names, persons sending in request numbers or other material of this type. No requests are complied with on the night of broadcasting—future programs being based upon such requests. The quality of any program, before broadcasting, is carefully censored.

The operating staff of WHAD comprises the following:

Herbert Waring and L. E. Cordes, transmitter operators at Marquette university; Ed Renft, announcer of programs emanating from Marquette university; E. S. Carpenter, studio director at Marquette university; Daniel Gellerup, operator and chief engineer of all remote control stations.

The Rev. John B. Kremer, department of physics of Marquette, is director of the university station.

WOMAN FIRST IN RADIO FARM QUIZ

Letters Tell How Broadcasts Help Rural Population Enjoy Life and Prosperity

CHICAGO.—How Radio helps the farmer in dollar and cents is revealed by the recent contest conducted over WLS, Sears-Roebuck station here.

To find out just how Radio benefits the farmer, WLS asked farm listeners to write a letter telling their individual experiences.

Winners in the contest have been announced by Edgar L. Bill, director of WLS. The first prize, a complete five-tube set, was awarded to Mrs. August Krause of Easton, Ill., for the best letter on "How Radio Helps Me on the Farm." Four other prizes were awarded.

"We're farmers by day and Radio fans by night," was the note that ran through the contest letters. Some said they considered the aerial art more valuable than the automobile. Writers pointed out how market reports helped to make and save money.

There is no drudgery to dishwashing, dusting or patchwork if there is music to work by, and the livelier the music the faster you work," wrote the first prize winner, Mrs. Krause.

"As a business proposition Radio has been a great asset through market and weather reports," writes Mrs. Steinbel, second prize winner. "When news by Radio told how the receipts of hogs at Chicago broke the record with 122,000 in one day, we delayed shipment of a carload until hogs raised a dollar higher. We raise 1,500 chickens a year. We heard WLS tell of a new and cheaper ration, tried it and raised our chickens much cheaper."

AMSCO Rheostats

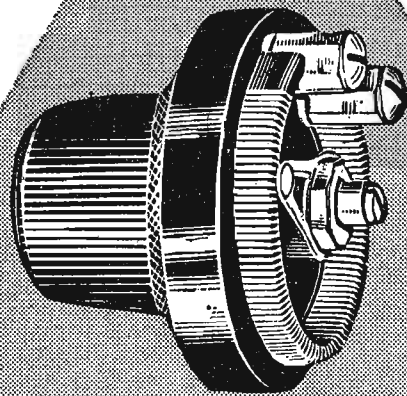

Specified for the Superhet

It doesn't pay to be circuit wise and rheostat foolish. The designers of the new Superheterodyne described in this issue of the *Radio Digest* have specified the AMSCO RHEOSTAT.

It is engineered to maintain uniform potential and to insure gradual increase or decrease of current, without electrical or mechanical noises in operation. Made with Bakelite Arrow Knob or Bakelite Dial. Two to fifty ohms.

Ask your dealer for AMSCO RHEOSTATS and accept no substitutes.

Amsco Products, Inc.
Broome & Lafayette
Sts., New York City



Write for "The Heart of the Hook-up", our valuable booklet about S.L.F. condensers, vernier dials and other radio parts.
Address Dept. O.

THE GRAND PRIX SPECIFIES PRECISE!

PRECISE instruments are generally selected by the scientific set-builder. He knows that Precise fine workmanship, perfect testing and laboratory precision produce the parts he desires for his set. Precise Instruments are distinguished as the discriminating set-builder's first choice.

Among the several Precise Instruments specified for builders of the Grand Prix 8-tube Receiver is the big Precise 480 Super Audio Transformer with its magnificent, deep, rich tones and great volume, the Supermulti-former, here illustrated, and the Brackets.

DEALERS

Write to our nearest branch office for information on how to make more money by handling the Complete Precise Line.

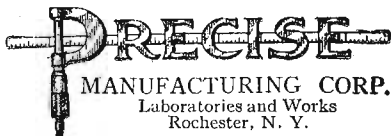

BRANCH OFFICES:

126 Liberty St., New York City	454 Builder's Exchange Minneapolis, Minn.
53 W. Jackson Blvd., Chicago, Ill.	1127 Pine St., St. Louis, Mo.
821 Market St., San Francisco, Cal.	701 A. O. U. W. Bldg., Little Rock, Ark.

CANADIAN DISTRIBUTORS:
Perkins Electric Ltd.,
Toronto, Montreal, Winnipeg



THE PRECISE SUPER-MULTI- FORMER

Contains four radio frequency transformers all accurately matched with identical characteristics. Encased in one unit. List price, \$20.00.



THE PRECISE FILTOFORMER

A combination radio frequency choke coil and bypass condenser constructed in one unit having three terminals. List Price, \$4.50.

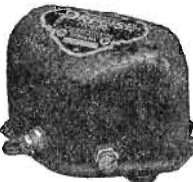

THE PRECISE No. 480

Designed to fill the need for a transformer which reproduces with magnificent amplification the actual creation as broadcast. Made in two ratios, 5 to 1 and 2 1/2 to 1. List price, either ratio, \$7.50.

YALE MAN AT WMC MIKE DOWN IN DIXIE

CHAMBERLIN NOW IN POST ONCE HELD BY GEO. HAY

New Director Jumps from Baseball Description to Present Position in Short Time

MEMPHIS.—Initiated into the fraternity of Radio announcers by the ruthless tribe of baseball fans who followed the fortunes of Fort Worth and Atlanta in the battle for Dixie supremacy as the result of the reports which he broadcast from WMC, the Commercial Appeal, Memphis, "Down in Dixie," Francis S. Chamberlin has successfully made his bow as new director of WMC, from whence came George D. Hay now of WLS.

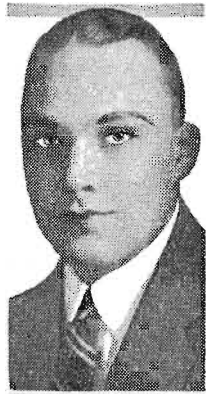

F. S. Chamberlin.

Communications of congratulation for the new announcer have already been received from various parts of the country, commending not only the clearness of enunciation, vocal carrying power and general management of programs, but also expressing approval of a certain subtle wittiness and happy personality sensed even through the air.

Yale Graduate and Football Star
Mr. Chamberlin is well qualified by education and general training to cope with the many problems attending the direction of WMC. He is a graduate of Yale in the class of 1924. During school and college he was always closely interested in athletics, being a member, in fact, of Dr. Bull's famous scrub football team which bore the brunt of practice scrimmages with the championship eleven captained by "Memphis Bill" Mallory. Later Mr. Chamberlin was elevated to the varsity squad itself.

His intimate knowledge of sports already has stood the new announcer in good stead, making possible a clear and

BRITISH STATESMAN QUIET BEFORE MIKE

PARIS.—Members of the staff of the French delegation at the League of Nations assembly at Geneva, who have returned, report an incident at one of the league meetings in which Austen Chamberlain was concerned.

At a breakfast offered by the international journalists present at Geneva, to the various statesmen assembled there, M. Vanderveelde, M. Painleve, Senor Quinones de Leon and others made various interesting and chatty remarks to their hosts. Mr. Chamberlain, however, was conspicuously silent. One of the journalists tackled him, but the British foreign secretary just shook his head and smiled, as he pointed to a microphone on the table in front of him:

"I would gladly tell you many things, gentlemen," he said, "for I have every confidence in the discretion of your profession. But . . . I have grave doubts about this instrument here. It has not learned discretion."

interesting account of the Dixie series, just closed, as well as the world's series which WMC also broadcast. Furthermore, Mr. Chamberlin possesses an additional background of European travel which permits him to add to the interest of certain programs.

Outlines Winter Plans

For the winter months the new director has outlined a schedule of entertainment which should increase the already strong popularity of the southern station. There will be those toe-tapping, shoulder-moving dance orchestras which really had their inception on Memphis' Beale street.

Now and then, during a regular Tuesday or Friday "midnight frolic," it is possible that some of those honest-to-goodness negro jazz organizations and blues singers will be put on the air. There will also be classical and semi-classical vocal and instrumental concerts.

Working with Mr. Chamberlin for the expanding success of WMC are those tried old friends, already known to Radio, "Miss Kitty" Nelson, secretary and assistant director, and the Gold Dust twins, Percy Root and Joe Kabakoff, who handle the mechanical department and also broadcast during the day time.

Single Tube Owners to Contest for DX Honors

Crosley Offers Prizes for Best Distance Records

CINCINNATI.—A national Radio contest for the best reception with any one tube Radio receiver, home or factory made, was inaugurated September first, by the Crosley Radio corporation here. This contest will continue until March 1, 1926, in order that owners may have six months time to report results during the winter months.

Powel Crosley, Jr., is offering \$1,000 as the capital prize, while a monthly prize of a pedigreed puppy, valued at \$100, will be given for the report of the best reception during each month. In case of tie, awards identical with that tied for, will be awarded all tying contestants.

Anybody may enter the contest upon sending an application card, which may be secured from authorized Crosley dealers, or by writing to the Cincinnati office of the Crosley Radio corporation.

Elect KOA Studio Director Head of Denver Musicians

DENVER.—KOA's studio director, Freeman H. Talbot, was recently elected president of the Musicians' Society of Denver, an organization of 150 leading teachers of music and professionals who are seeking to foster better music and standardize the profession. Mr. Talbot is widely known as one of the originators of the famous Denver Music Week association, which he has served as executive secretary since its inception more than six years ago.

Radio Travels 2,300 Miles to Tell of Nearby Event

SAN FRANCISCO.—Inhabitants of the island of Kauai, fifteen miles from the spot where Commander John Rodgers and crew of the ill-fated seaplane PN9 were found drifting, received their first news of the rescue over Station KGO, located in Oakland, California, 2,300 miles away, and rushed down to the bay in time to aid the half starved men to land. The story came to light in a letter from the KGO listener on Kauai.

LAND LINES TO LINK WGY AND THE WEST

SCHENECTADY PLANT WILL REACH OUT FOR SHOWS

General Electric String Adds Four More New York Cities to High- Power Plant

SCHENECTADY, N. Y.—Leading musical events of western and central New York state cities will be made available to the international audience of WGY here as a result of wire-connecting Buffalo, Rochester, Syracuse and Utica to the transmitting equipment of the station.

WGY is already connected by wire to Albany, Poughkeepsie and New York, and through WJZ, New York, and WRC, Washington. Leading musical events of Washington are thus conveyed to WGY.

By means of the line connections between WGY and the western New York cities, programs originating in any of the connected cities may be relayed by wire to New York and Washington as well as Schenectady. In Buffalo, Syracuse, Rochester and Utica will be remote control stations and studios.

WGY Using 50,000 Watts

Broadcasting through WGY means more than transmission on 379.5 meters with 3,500 watts power. By special authorization from the department of commerce WGY is permitted to use 50,000 watts of power two nights a week, Saturday and Sunday.

Every day, except Sunday, the WGY programs are also broadcast on 41.88 meters, 109 meters and 1,560 meters on special experimental licenses. Transmitters for these special transmissions are located at the South Schenectady developmental laboratory of the General Electric company where engineers are gathering data on transmission at different wave lengths, with various amounts of power and with a variety of antenna systems.

The 41.88 meter transmission has been found to be excellent for daylight transmission and reception and signals on this wave have been heard in Pretoria, South Africa and Auckland, New Zealand.

A committee known as the "Comite d'Action et de Propagande de la Radiophonie Francaise" is planning to erect in Paris a new and powerful broadcaster.

FOURTH ANNUAL

CHICAGO RADIO SHOW

COLISEUM—CHICAGO

November 17 to 22 inclusive, 1925

PRESENTED BY
THE RADIO MANUFACTURERS' SHOW ASSOCIATION

U. J. HERRMANN
Managing Director

127 N. Dearborn St.
Chicago
611 Times Bldg.
NEW YORK

G. CLAYTON IRWIN, JR.
General Manager

"The World's Foremost Radio Expositions"

ADVANCE PROGRAMS FOR THE WEEK

Saturday, October 24

Headliners Today

Eastern	Central	Mountain	Pacific
8	7	6	5
KFAB (340.7)—Buick Little symphony.			
KSD (545.1)—Stage specialties.			
WEEI (348.6)—American House Marimba band.			
8:30	7:30	6:30	5:30
KDKA (309.1)—Westinghouse band concert.			
WHAS (400)—Royal Peacock orchestra.			
9	8	7	6
WLW (422.3)—"The Valiant," play.			
10	9	8	7
WEAF (491.5)—Mystery quartet.			
10:30	9:30	8:30	7:30
WPG (299.8)—Silver Slipper.			
WRC (468.5)—Crandall's Saturday Nighters.			
WSAI (326)—Sextet, featuring "Eileen."			
11	10	9	8
KFVE (240)—Dance night.			
KGO (361.2)—Selections from "Aida."			
KTHS—Capt. Carson and his fiddle band.			
11:30	10:30	9:30	8:30
WJR (517)—Jewett Jesters.			
12	11	10	9
WFAA (475.9)—Happyland Syncopaters.			

Saturday, silent night for: CFCA, CHIC, CNRA, CNRC, CNRE, CNRM, CNRR, CNRT, CNRV, CNRW, KFAU, KFDK, KFMG, KFMX, KFRU, KFUO, KLDS, KMA, KOB, KTAB, KUOM, KWSC, WBPAP, WBZ, WCAU, WCX, WEAQ, WEBJ, WGPC, WHAD, WHAZ, WHB, WHN, WHO, WIP, WJAR, WLVK, WKAQ, WOS, WSMB, WSUI, WTAG, WTIC, WWL.

Eastern Time Stations

CFCA, Toronto, Can. (356), 2:15 p. m., football match, Argonauts, Hamilton Tigers.

CNRO, Ottawa, Can. (435), 8 p. m., Chateau Laurier concert orchestra; 9, Mrs. Harry Underwood, contralto; Arthur Donaldson, euphonium soloist; Mrs. Horace Butler, soprano; Uncle Dick, reader; Roy Carson, baritone; comedy selections, Jack Grace, Jack Powell; Chateau Laurier dance orchestra.

KDKA, Pittsburgh, Pa. (309.1), 6:15 p. m., dinner concert; 7:30, children's period; 8:30, Westinghouse band concert, T. J. Vastine, conductor; Ernest Meludie, baritone; 9:30, concert.

PWX, Havana, Cuba (400), 8:30 p. m., concert, Valle, Fuentes, Fernandez, Mrs. Valle.

WAHG, Richmond Hill, N. Y. (315.6), 12-12:55 p. m., musical program; 12-1 a. m., orchestra.

WBZ, Springfield, Mass. (333.1), 3 p. m., Harvard-Dartmouth football game, play-by-play.

WGAE, Pittsburgh, Pa. (461.3), 6:30 p. m., dinner concert, William Penn hotel; 7:30, Uncle Kaybee; 8, address; 8:30, concert.

WGX, Detroit, Mich. (517), 6 p. m., dinner concert, Book-Cadillac hotel.

WEAF, New York, N. Y. (491.5), 1:45-3, football results; 4-5, Elmer Grosse and his orchestra; 6-7, dinner music, Waldorf-Astoria; 7-7:15, James McKinley Rose, tenor; 7:15-7:30, Fred Ruzicki, violinist; 7:30-7:45, May Singhi Brown, banjo; Peter De Rose pianist; 7:45-8, WPAF Light Opera quartet; 8-8:15, Helen Drew, pianist; 8:15-8:30, WPAF Light Opera quartet; 8:30-10, concert, United States army band; 10-10:15, Mystery quartet; 10:15-10:45, Parnassus string trio; 10:45-11, Mystery quartet; 11-12, Vincent Lopez and his orchestra.

WEAR, Cleveland, Ohio (389.4), 7-8 p. m., dinner concert, Marjorie Moore's Melody Maids.

WEEI, Boston, Mass. (476), 7:15 p. m., talk, Malcolm E. Nichols, candidate for Mayor of Boston; 8, American House Marimba band, orchestra; 9, Dok Eisenberg and his Sinfonians.

WGSS, New York, N. Y. (315.6), 2-3 p. m., Bob Kinnear's College club orchestra; 3-3:10, Deborah Lipson, soprano; 3:10-3:40, drawing room players; 3:40-3:50, Deborah Lipson; 6-6:30, Uncle Geesbe; 6:30-7, Vincent Sorey's concert and dance orchestra; 7-7:10, ballroom dance instruction, Arthur Murray; 7:10-7:30, Vincent Sorey's orchestra; 7:30-7:40, Peter Maier, songs with triple; 7:40-7:50, Joseph Balligan, songs; 7:50-8, Maher and Halligan; 8-8:30, Marzoukian oriental orchestra and singers; 8:30-8:40, Oyoza Mizuki, baritone; 8:40-8:50, Irving Arday, violinist; 8:50-9, Oyoza Mizuki; 9-9:10, Inez Quick, soprano; 9:10-9:20, Irving Arday; 9:20-9:30, Inez Quick; 9:30-10:30, program, Warner's theater; 10:30-11:30, Arrowhead Inn orchestra.

WGBU, Fulford-by-the-Sea, Fla. (278), 6:30-7:30 p. m., piano solos, Theresa Horn; 10-12, Miami Daily Tab musical melange; 12-1 a. m., Blue Stevie's orchestra.

WGCP, New York, N. Y. (315.6), 3-3:15 p. m., Henry Roger, pianist; 3:15-3:30, Ukulele Lon Hayes; 3:30-3:45, Henrietta; 3:45-4, Maurice Abraham; 3:45-4, Ona Welch, pianist; 4-4:15, Rust and Henrietta; 4:15-4:30, Richard Cheatham's Club Basia orchestra; 4:45-5, Mr. and Mrs. John A. Hartney, piano, songs.

WGR, Buffalo, N. Y. (319), 1:45 p. m., jointly with WEAF, intercollegiate football game, Pennsylvania vs. Chicago; 2:30-4:30, 6:30-7:30 and 8:30-10:30, program, Buffalo Radio show featuring Eilenbach's orchestra.

WGY, Schenectady, N. Y. (379.5), 3 p. m., University of Pennsylvania vs. University of Chicago football game, Franklin field; 9:30, Hotel Ten Eyck dance orchestra; Edward Rice, violinist; Ollie Yetru, pianist.

WHAR, Atlantic City, N. J. (275), 7:50 p. m., lecture period; 8, Seaside hotel trio.

WIP, Philadelphia, Pa. (508.2), 1 p. m., organ recital, Germantown theater; 3, University of Pennsylvania-University of Chicago football game; 6:05, Benjamin Franklin concert orchestra; 7, songs, Margaret Keenan; 8, "The Diamond and Its Colored Brothers," Prof. Freeman P. Strump; 8:15, sports event; 8:45-9, Francis D'Elisa; 8:50, U. of Pittsburgh band; 9, American male quartet; 10:05, Benjamin Franklin dance orchestra; 11:05 organ recital.

WJAR, Providence, R. I. (305.9), 2:45 p. m., U. of Pa.-U. of Chicago, football.

WJR, Detroit, Mich. (517), 2 p. m., Quantico Marines-University of Detroit, football; 7, Hilton Dressau, baritone; 9, Jean Goldkette's vocalists; Hilton Dressau, baritone; 10, Jean Goldkette's Victor Recording orchestra; 11:30, Jewett Jesters.

WLIT, Philadelphia, Pa. (394.5), 12:02 p. m., daily almanac; Stanley theater organ recital; Arcadia cafe concert orchestra; 2, Arcadia cafe concert orchestra; 4:30, dance orchestra; 7:30, Benjamin Franklin concert orchestra.

WNCA, New York, N. Y. (340.7), 6-6:30 p. m., Olenit Hall and his Hotel McAlpin string ensemble; 6:30-7:30, Frank Wunderlich and his Sino Brook orchestra; 7:30-8, May Singhi Brown, Peter DeRose and ensemble; 8-8:15, talk, George Bogner; 8:15-8:30, George Flanders, pianist; 8:30-9, Hon. Justice Joseph E. McKee; 9-9:30, Alfred Orner, tenor; 9:30-10, Eugene Lee Proulx, pianist; 10-10:30, Ross Pearson, baritone; 10:30-11, Helen Muller, soprano; 11-12, Bernie Golden and his Hotel McAlpin orchestra.

High Lights of the Week

CAPTAIN John A. Carson and his band are visiting KTHS Saturday evening. Captain John's fiddle tunes need no introduction for he is one of the original pioneer Radio artists and was formerly well known at WSB. A curious kind of a band makes its Radio debut at WEEI this same evening when the American House Marimba band goes on the air.

The Germantown theater became well known to Radio fans last year during the weekly opera broadcasts from WIP. These will be resumed this year with "Manon." Operatic stars, chorus and orchestra will make this Sunday program popular. Marshall W. Giselman, who is a famous San Francisco organist, is to be a weekly Sunday afternoon feature at KPO.

Monday night the Rensselaer Polytechnic students get together for their first monthly program at WHAZ. The students symphony orchestra will be one of the features. WCCO announces an unusual program with the Fort Snelling third infantry band. This is one of the oldest regiments and bands in the United States.

The Indian war cry, the ceremonial feast, and the medicine man's songs will once again enter the homes of white men Tuesday when WTIC illustrates the music of the American Indian by means of orchestras, mixed quartets, and soloists. A Mexican artist of note will be heard from

WFAA Tuesday. Senor Enrique Rasaplo has charmed his own republic with his violin selections and will now please the invisible audience of WFAA. Tuesday is Navy day and the air will be heavy with martial music from many stations.

The people of Argentina have given to the people of the United States a statue of Gen. Jose de San Martin, the outstanding hero in the fight for Argentina independence. Wednesday afternoon at 3 p. m. eastern time this statue will be unveiled and the unveiling ceremony broadcast by WRC. President Coolidge and Ambassador Honorio Pueyrredon of Argentina will speak. At 3 p. m. central time William Howard Taft, Chief Justice of the United States, will deliver the dedicatory address of the Alphonse Taft College of Law which will be sent out over the air from WSAI.

The Sleepy Hollow trio, which, according to mail applause, is one of the most popular features of KDKA, will give a classical program Thursday at this station. The trio gets its name from "The Sleepy Hollow Tune" which was composed by Richard Kountz, pianist of the group. Albert Berne, who has a rich baritone voice, will interpret old English songs at WKRC.

A tabloid presentation of "Faust" Friday will be given under the direction of Gwilyn Miles from KSD, St. Louis.

WOR, Newark, N. J. (405.2), 3:15-3:45 p. m., Zit's Casino orchestra; 6:15-7:15, Hotel Shelton orchestra; 7:15-7:30, sports talk; 7:30-8, Van's Collegians; 11-11:30, Citro's orchestra.

WPG, Atlantic City, N. J. (299.8), 1:30 p. m., Hotel Morton luncheon music; 6:45, Arthur Scott Brook, organist; 7, Hotel Traymore dinner music; 8, program, 9, Chalfonte-Haddon hall evening concert; 10:30, The Silver Slipper.

WRC, Washington, D. C. (469), 1 p. m., New Willard hotel orchestra; 7, Hotel Washington orchestra; 8, Bible talk; 8:15, musical program; 10:30, Crandall's Saturday Nighters.

WREO, Lansing, Mich. (285.5), 6-7 p. m., dinner concert; 10-12, Speed-Wagon serenaders.

WTAM, Cleveland, Ohio (389.4), 12-1 p. m., Euclid music studio; 6-7, Hotel Hollenden studio, Hotel Hollenden orchestra; 8-9, Guy Lombardo and his Royal Canadians; 9-12, Ev Jones and the Coo Coo club; Joe Ferte, tenor.

WWI, Detroit, Mich. (352.7), 12:05 p. m., Jules Kleib's Hotel Statler orchestra; 3, Detroit News orchestra.

Central Time Stations

KFAB, Lincoln, Neb. (340.7), 5:30-6:30 p. m., Buick Little symphony, Belshaw's orchestra; 8:30-9:30, Schmolter and Mueller musical program; Oscar Alexis, baritone.

KFNF, Shenandoah, Ia. (266), 7 p. m., concert, Mound City, Mo.; George Walker, director.

KFVE, University City, Mo. (240), 6:30 p. m., amusement review, Romaine Fielding; 10, dance numbers; Gene Witacker's orchestra; comedy and jazz.

KMA, Shenandoah, Iowa (252), 6-7 p. m., popular concert, chimes, William Howie; 9-11, program.

KPRC, Houston, Texas (296.9), 5:30 p. m., Universal Bible class, Rev. M. M. Wolf; 7:30, pipe organ concert, South End Christian church; W. R. Shriner, organist; 8, Robert Chambers, baritone; Dorothy Chambers, pianist; 8:30, saxophone and piano recital, Mr. and Mrs. Ralph Pulley; 9, program; 11, Baytown band.

KSD, St. Louis, Mo. (545.1), 7 p. m., orchestral program, stage specialties, Grand Central theater.

KTHS, Hot Springs National Park, Ark. (374.8), 9:10-9:45 p. m., dance concert, 10-piece New Arlington orchestra; 9:45-10:30, fiddle tunes, Captain John Carson and his band; 10:30-11, dance selections.

KYW, Chicago, Ill. (535.4), 11:35 a. m., table talk, Anna Peterson; 1:35-3 p. m., frolic; 6:35-7, bedtime story, Uncle Bob; 7-7:30, dinner concert, Congress hotel; 8-9, musical program.

WAMD, Minneapolis, Minn. (243.8), 12 p. m., Marion Lotta, contralto; George Sankey, pianist; Larry Dunn, baritone; Sylvan Frase, banjoist; 7 p. m., Earl Bedard, banjoist; Bill Reed, pianist; Melvin Ginzberg, violinist; Henry Bessness, accompanist; Fred Robe, Robert Melchor, duo; Arline Snure, soprano; Dale Snure, accompanist.

WBAP, Fort Worth, Texas (475.9), 7:30 p. m., Sunday school lesson, Mrs. W. P. Barnum.

WBJD, Moosehart, Ill. (302.3), 6-6:30 p. m., Howard

WBBM, Chicago, Ill. (226), 5:30-6 p. m., Kiddies' Joy-Dinger club; 8-11, Sunset quartet; Babbe and Barr; Blue Deuces; Charlie Garland, Nate Caldwell, Eddie Loftus, George Marbach, tenor; Corrine Jordan; 11-11:30, Carl Strudel, baritone; Joseph Raleff, pianist; Torrid duo; Honky Tonk Gloom Chasers; Sue Olmsted; Montmartre orchestra; 1-2, Hoty Totsy hour; Samovar orchestra; Charlie Garland and artists.

WBBR, New York, N. Y. (272.6), 8 p. m., Dr. Hans Haag, violinist; 8:15, Bible questions and answers, Judge Rutherford; 8:45, Dr. Hans Haag, violinist.

WCCO, Minneapolis-St. Paul, Minn. (416.4), 2 p. m., Minnesota vs. Notre Dame football game; 6:15, dinner concert, Chadbourne's Nicollet hotel orchestra; 8, "Frisette Philosophies," Rev. Roy L. Smith, Pastor Simpson; 8:15, musical program; 10:05, dance program, Wallie Erickson's Coliseum orchestra.

WDAF, Kansas City, Mo. (365.6), 6-7 p. m., School of the Air; piano tuning-in-number on the Duo-Art; address, Roger W. Babson; organ music, Royal theater; Trionon ensemble; 11:45-1 a. m., Nighthawk frolic; Merry Old Chick, Plantation players; Johnnie Campbell's K. C. club orchestra; Earl Coleman's orchestra; Eddie Kuhn's K. C. Athletic club orchestra.

WEBB, Chicago, Ill. (370.2), 7:30-8:30 p. m., Oriole orchestra; Howard Neumiller, pianist; 9:30-10:30, Oriole orchestra; Marie Kelly, reader; Kay Ronayne, sonstner; 11:30-1 a. m., Oriole orchestra; Frank Grief, tenor; Blanche and Rudi Bale; Wayne Myers, reader.

WENR, Chicago, Ill. (286), 6-7 p. m., dinner concert; Rauland lyric trio; George Unger, violinist; vocal numbers; 8-10, popular program; Walter Peterson, soprano; 12-2 a. m., frolic; Frank Westphal and his All-American Pioneers; Marie Tully, harmonica soloist.

WFAA, Dallas, Texas (475.9), 6:30-7:30 p. m., Ford's Texas Trumpeters; 8:30-9:30, Joseph Rucker, basso; Mrs. Rucker, pianist; 11-12, Trent's Happyland syncopators.

WGN, Chicago, Ill. (370.2), 12:40 p. m., Drake concert ensemble, Blackstone string quintet; 2:30, artist series, Lynn and Bealy; 3:30-4:15, tea time music, Marshall Fields tea room orchestra; 6:30-7, Drake concert ensemble, Blackstone string quintet; 8-9, WGN string trio; 10-11, Jack Chapman's and Blackstone hotel dance orchestras.

WHAD, Milwaukee, Wis. (278), 6-7 p. m., Arthur Richter, organist.

WHAS, Louisville, Ky. (399.8), 7:30-9 p. m., concert, Royal Peacock orchestra; Richard Kent, director.

WHT, Deerfield, Ill. (399.8), 8 p. m., classical program, Grayling's string trio; Jean Carlson, soprano; Eleanor Kaplan, violinist; W. Dyckman, baritone; Edwin Kemp, tenor; Al Carney, organist; (238), 7:45-9:15, musical features; (399.8), 9:30, Jelke entertainers; Klieben Klenzer Klusses, Harry Langdon, harmonica soloist; Marie Wright, soprano; Golden trio; Oscar Hencher, tenor; Al Carney, organist; 12, Pat Barnes and Al Carney.

WJLD, Moosehart, Ill. (302.3), 6-6:30 p. m., Howard

Peterson, organist; 6:30-7, Belmont trio; 8-9, Moosehart children; talk, M. P. Adams; 10-11, Fayette Miller, Ruth Allanson, Robert Duphiney, Robert Dewar, Edward Greaning; 12-1, announced.

WKRC, Cincinnati, Ohio (422.3), 10 p. m., Marion McKay and his orchestra; popular piano selections.

WLBB, Elgin, Ill. (302.8), 7-8 p. m., dinner concert, Drake concert ensemble; Blackstone string quintet; 9-10, Fred Haran's orchestra; organ recital; 10-11, Jack Chapman's and the Blackstone hotel dance orchestras; jazz artists; 1-2 a. m., Jack Chapman's and the Blackstone hotel dance orchestras; jazz.

WLS, Chicago, Ill. (344.6), 7:15 p. m., Ralph Emerson, organist; Grace Wilson, contralto; Ideal quartet; Barn dance fiddlers; Tony Corcoran, baritone; Nubs Allan, contralto; Chubby Parker; 10, Kentucky serenaders; Abe Lyman's College Inn orchestra; 11-12, WLS minstrels.

WLW, Cincinnati, Ohio (422.3), 7 p. m., Johanna Grosse, organist; 7:15, Crosby instrument trio; 7:30, Louis John Johnen, baritone; 8, "The Valiant," play.

WMAQ, Chicago, Ill. (447.5), 6 p. m., Chicago theater organ; 6:30, Hotel LaSalle orchestra; 8, Daw and Pratt; 8:30, "Australian Aborigines," Capt. Kilroy Harris; 9, Chicago theater.

WMBB, Chicago, Ill. (250), 7-8 p. m., Trionon duo; Beatrice Teller, M. Morgan, Hazel O'Neil, Jean Ballard, Paul Caroux, John Everett; 9-11, Trionon orchestra; Edward Hines, Jimmy Egerton, Woodrow theater orchestra, Clyde Hager, Dave Williams, Elsie White.

WMC, Memphis, Tenn. (499.7), 8:30 p. m., musicale.

WOAW, Omaha, Neb. (556), 6 p. m., Bialto orchestra; 7, orchestra; 7:30, speakers' hour; 9, First Christian church orchestra; 11, Arthur Hays and his organ jubilee.

WOC, Davenport, Iowa (483.6), 6:30 p. m., sandman; 9-10, Ray Dum, tenor; Alice O'Connor, O'Donnell, soprano; Toher trio; 11-12, LeClair hotel orchestra; Peter MacArthur, baritone.

WOK, Chicago, Ill. (217.3), 5:30-7 p. m., Robert York, tenor; Harriet Doty, contralto; Banks Kennedy, organist; LeRoy North, organist; 10-1, Fred Wiltner, pianist; Harold Morava, tenor; Herman Sinaiko, violinist; Harriet Lee, contralto; WOK string trio; Ada Tiller, soprano; Bill Hay, bass; Banks Kennedy, organist; 10-1, LeRoy North, pianist; Sandy Meek, tenor.

WORD, Batavia, Ill. (275), 8 p. m., program, Webster hotel; 8:30, Chicago motor club speaker.

WQJ, Chicago, Ill. (447.5), 7-8 p. m., dinner concert, Ralph Williams and his Rainbo Gardens orchestra; Edith Dady, whistler; Muriel Kenecally, soprano; Otto A. Moore, baritone; LaVerne Hanson, accompanist; 10-3 a. m., Ralph Williams and his Rainbo Skylarks; Jerry Sullivan; Rose Vanderbosch, soprano and pianist; Hal Lansing and his uke; Jane Lee, comedienne; The Melodians; Everett George Ope, character reader; Tillie Miller, contralto; Clarence Theodors, tenor; Sandy Meek, Scotch tenor; Harry Sosnick, pianist; Bert Davis, Williamson Brothers, steel guitarists.

WSAI, Cincinnati, Ohio (326), 2:30-5 p. m., University of Cincinnati-Denison university football game; 7:45, children's stories; 8, WSAI chimes, Robert Badgley; 8:15, Bicycle playing card sextet, "Eileen"; 9, U. S. playing card weekly news review; 9:15, "Eileen," Bicycle playing card sextet.

WSM, Nashville, Tenn. (282.8), 2:30 p. m., Vanderbilt football game.

WSMB, New Orleans, La. (315), 8:30-10:30 p. m., St. Matthews Evangelical choir, Mrs. Isabelle M. Pilcher, organist.

Mountain Time Stations

KFWA, Ogden, Utah (261), 5-6 p. m., Ogden Radio dealers' program; 9-12, Olie Reeves and his orchestra.

KOA, Denver, Colo. (322.4), 9 p. m., orchestra music program.

Pacific Time Stations

KFOA, Seattle, Wash. (454.3), 8:30-9:30 p. m., program; 9:30-11:30, Eddie Harness and his orchestra.

KEFG, Hollywood, Calif. (238), 9 a. m., Dad's hour, Dad King; 8-9 p. m., Maggie O'Shea, the blarney girl and her vaudeville hour; 9-10, Ben Sears' Old Times dance.

KFWB, Hollywood, Calif. (252), 7:30 p. m., microphone reviews; 8-9, Warner Brothers syncopators; Barbara Bunnell, blue singer; Anna Margaret Travers, soprano; Fred Hayn, flutist; 9-10, Nellie Lind, song and Lucile Baker, double piano numbers; Grace Walper, soprano; Carlyle Scott, tenor, and Valry Sisters, vocal duets; 10-11, Warner Brothers frolic, direction Norman Manning.

KGO, Oakland, Calif. (361), 4-5:30 p. m., concert orchestra, Hotel Francis; Vinton LaFerra, conductor; 8, sport review, Al Santoro; 8:10, National Carbon company program; Boy Scout program; piano recital, Edna Drynan Carlson; selections from "Aida," grand opera; 10-12, dance music, Hotel St. Francis.

KGW, Portland, Ore. (491.5), 10-12 p. m., dance music, Multnomah hotel.

KHJ, Los Angeles, Calif. (405.2), 6-6:30 p. m., Leigh-ton's Arcade orchestra; Jack Cronshaw, leader; 6:30-7:30, Prof. Herzog's history story; Gene Smith, pianist; Eugene Caldwell, dialect reader; Henrietta Poland, readings; Dolly Wright and Uncle Remus as guest announcer; 8-10, de luxe program, arranged and presented by J. Howard Johnson; 10-11:30, Art Heckman's Baltimore hotel dance orchestra, Frank Ellis, leader; 11:30-2 a. m., Lost Angels of KEJ with Walter Biddick, Lost Angel orchestra, O. G. Pirie, Louis F. Klein and others.

KJR, Seattle, Wash. (384.4), 1:15 p. m., organ recital; 2, home helps Bernice Redington; 8:30, L. C. Warner company studio program.

KNX, Hollywood, Calif. (336.9), 5:30-6:15 p. m., Wurlitzer organ studio, Town Center; 6:15, travel talk, W. F. Alder; 6:30-7, Awator Kent Radio orchestra, Paul Einstein, leader; 7, talk on insect life, Harry W. McSpadden; 7:15, church announcements; 7:30-8, Wurlitzer pipe organ studio; 8:10, KNX feature, program, arranged by Carrie Preston Hillmeister; 10-11, Ray West's Coconut Grove dance orchestra from Ambassador hotel; 11-2 a. m., Hollywood night with some movie stars and Radio favorites.

KPO, San Francisco, Calif. (428.3), 6:35-7 p. m., Waldemar Lind and the States Restaurant orchestra; 8-12, Cabiria cafe orchestra, Jack Coakley, director.

KTCL, Seattle, Wash. (305.9), 6:50-7:15 p. m., Hermie King and his super-soloists; 8:30-12, Uncle Hal and his stars of Radio.

Sunday, October 25

Headliners Today

Eastern	Central	Mountain	Pacific
7:20	6:20	5:20	4:20
WEAF (491.5)—Capitol Gang.			
8	7	6	5
KYW (535.4)—Sunday Evening club.			
9:45	8:45	7:45	6:45
WIP (508.2)—"Manon," opera.			
10	9	8	7
WFAA (475.9)—Little symphony orchestra.			
WGN (370.2)—Drake ensemble.			
WSAI (326)—Concert orchestra.			
11	10	9	8
KFVE (240)—Sacred concert.			
KHJ (405.2)—Special program.			
KTHS (374.8)—Frolic.			
12	11	10	9
KNX (336.9)—Russian String trio.			
WBAP (475.9)—Shelly Lee Alley's orchestra.			

(Continued on page 9)



The Foolish Entertainers, WRC's performing announcers, are presenting a light program every Friday at WRC. They are, left to right, Ellsworth Tompkins, baritone; George F. Ross, pianist, and Norman Brokenshire, ukulele specialist.

FIDDLIN' JOHN CARSON VISITS KTTHS

Sunday, October 18

(Continued from page 8)

Sunday, silent night for: CHIC, CKNC, CNRA, CNRC, CNRE, CNRM, CNRO, CNRR, CNRT, CNRW, CNRW, KFAB, KFAU, KFMQ, KFOA, KFPG, KFWA, KMA, KOB, KSD, KWSC, WAHG, WBAP, WCAU, WCX, WDAF, WEAQ, WEBJ, WFI, WGBS, WGPC, WHAD, WHAS, WHAZ, WJR, WKAQ, WLIT, WMC, WOK, WOO, WOR, WORD, WRC, WSAI, WSAM, WTAM, WTIC.

Eastern Time Stations

CFCA, Toronto, Can. (356), 11 a. m., Walmer Road Baptist church; 7 p. m., St. Paul's Anglican church service.

KDKA, Pittsburgh, Pa. (309.1), 10:45 a. m., church service; 4 p. m., Dr. Chavies, Heinrich, organist; 4:45, vesper service, Shadyside Presbyterian church; 6:30, Pittsburgh Athletic association orchestra; 7:45, church service.

WBRR, New York, N. Y. (272.6), 9 p. m., I. B. S. A. choral singers; 9:05, violin duets, Prof. C. Rohner, Carl Parks; 9:15, Bible lecture, Judge Rutherford; 9:50, I. B. S. A. choral singers; 10:05, violin duets; 10:20, I. B. S. A. choral singers.

WBZ, Springfield, Mass. (333.1), 10:55 a. m., services, South Congregational church, Rev. James Gordon Gilkey, pastor; Wilson Moog, organist; 24-voice choir; 8 p. m., "Starlore—Comets and Their Curious Capers," George Leo Patterson; 8:30, Myra Smith, soprano; Frank Hardy, tenor; Harold Pearson, accompanist; 9, E. Rupert Siroom, organist; Arthur R. Siroom, violinist; Dorothy M. Greeley, contralto.

WCAU, Philadelphia, Pa. (277.6), 5 p. m., Robert Fraser, blind gospel singer; 5:15, Undenominational Radio church service, Rev. J. W. Stockwell, pastor; 5:25, "The Third Gospel Book," Rev. John W. Stockwell; 5:35, recital; 5:45, "You Decide," Rev. John W. Stockwell; 6, Hotel Pennsylvania concert orchestra.

WCX, Detroit, Mich. (517), 10:30 a. m., services, Central Methodist Episcopal church.

WEAF, New York, N. Y. (491.5), 2-3:45 p. m., "Sunday Hymn Sing," Federation of Churches; 3:45-5:30, men's conference, Bedford branch, Y. M. C. A.; 7:20-9:15, "Capitol Gang," Capitol theater; 9:15-10:15, Atwater Kent Radio hour.

WEEL, Boston, Mass. (476), 3:45 p. m., Men's Conference, Dr. S. Parkes Cadman; 7:20, Major Bowes and his Capitol theater family; 9:15, Atwater Kent hour.

WGBS, New York, N. Y. (315.6), 3:30-4:30 p. m., program, Warner's theater.

WGBU, Fulford-By-the-Sea, Fla. (278), 9-11 p. m., sacred concert.

WGR, Buffalo, N. Y. (319), 3 p. m., vesper service, Buffalo Council of Churches; 7:45, Central Presbyterian church service; 9:15-10:15, jointly with WEAF, Atwater Kent Radio artists.

WGY, Schenectady, N. Y. (379.5), 10:45 a. m., services, First Methodist Episcopal church; Dr. Philip Frick, pastor; 12:30, p. m., orchestra program, Rivoli theater; Hugo Riesenfeld, conductor; 7:30, services, First Methodist Episcopal church; Dr. Philip Frick, pastor; Godfrey Ludlow, violinist.

KFMX, Carleton, Minn. (337), 7-8 p. m., college vesper service.

KFNF, Shenandoah, Iowa (266), 10:45 a. m., morning worship, First M. E. church; 2:30 p. m., Golden Rule song service; 3, Christian Sunday school, Lee Slusher; 6:30, Golden Rule Circle services; 7:30, Christian church services.

KFRU, Columbia, Mo. (499.7), 7:30 a. m., hymns, Stephens college sextet; reading, Bernadine Agle; "Money or Christ," Nellie Lee Holt; 9:20, Valborg Leland, violinist; Olivia Noel, pianist; hymns, Ernest Cox director; reading, Kenneth Lancaster; prayer, Fred Dixon; Stephens college glee club; "Life Problems—Our Love Affairs," Jessie Burrall; 7:30 p. m., evening student service; Tillman Merritt, organist; quartet; reading, Mahlan Euhank; address, Hon. W. L. Nelson.

KFUO, St. Louis, Mo. (545.1), 9:15 p. m., "Jesus Christ—Who Is He?" Rev. W. D. Peters.

KFVE, University City, Mo. (240), 6:30 p. m., amusement review, Romaine Felding; 10, "Life's Race," Rev. C. W. Davis; sacred concert.

KLDS, Independence, Mo. (441), 11 a. m., Stone church services; Robert Miller, organist; Stone church choir; 6:30 p. m., vesper services; KLDS ladies' quartet; Orlando Nace, violinist; Gerald Johnson, tenor; sermon, U. W. Greene; 9, Pauline Etzenhauer, organist; Lillian Green, violinist; I. A. Smith, soprano; sermon, H. O. Smith.

KMA, Shenandoah, Iowa (252), 4-6 p. m., vesper service.

KPRC, Houston, Texas (296.9), 10:45 a. m., services, First Christian church, Rev. Claud L. Jones, pastor; W. L. Claypool, organist; 7:30 p. m., chimes, St. Paul Methodist church; 8, services, St. Paul Metho-

Olga Samaroff, considered by many America's greatest woman pianist, will be one of the guests during the Atwater Kent hour Sunday October 25, at WEA F and chain.



Rev. Hugh L. McMenamin, rector, Immaculate Conception cathedral, whose services will be given from KOA Sunday October 25.



Mable Garrison, soprano, formerly with the Metropolitan Opera company, will be the other guest artist of the Atwater Kent company at WEA F and chain, Sunday, October 25.

dist church, Rev. K. P. Barton pastor; 9:30, Julian Paul Blitz and his Hotel Brazos orchestra.

KTTHS, Hot Springs National Park, Ark. (374.8), 11 a. m.-12:15 p. m., services, First Presbyterian church, Rev. Chaucey Hickok, pastor; Frances Hardin, organist; 9-10, deluxe classical recital, New Arlington Meyer Davis orchestra, soloists; Lon Chassy, director; 10-11, frolic, Bennie Ford's DeSoto Garden orchestra.

KYW, Chicago, Ill. (535.4), 11 a. m., Central church service; 4, studio concert hour, Edwin Harper; 7, Chicago Sunday Evening club.

WAMD, Minneapolis, Minn. (243.8), 6 p. m., dinner concert, George Osborn's orchestra; 9:30, popular program, George Townsend, cornetist; Leslie Lindeau, accompanist; Carl Schmidt, tenor; Bayne Cummins, accompanist; Julia Barr, soprano; Marie Fuller, pianist; 10:30, Skyrocket frolic, orchestra.

WBAP, Fort Worth, Texas (475.9), 11 a. m., First Methodist church, Rev. J. W. Bergin; 12:30, p. m., comic section, Uncle Billy; 11 p. m., popular music, Shelby Lee Alley's orchestra.

WBBM, Chicago, Ill. (226), 4-6 p. m., Harmony girls; Edith Carpenter, Grace Ingram; Frank King and his Yankee band; Charlie Garland, Nate Caldwell, Eddie Loftus, Corrine Jordan; Elsie Deuces, Harold Anderson; 8-10, Frances Ingram, operatic contralto; Joseph Raleff, duo art pianist; Jean St. Anne, French baritone; Ted Colman, cellist; Sunset quartet, Samovar orchestra; 12-2 a. m., Nutty club.

WGBD, Zion, Ill. (344.6), 8 p. m., mixed quartet and celestial ball quartet; Mrs. Thomas and Mrs. LaRose, soprano, contralto; Dorothy and Ralph Bull, soprano and tenor; Barton and Thomas, tenor and baritone; Gerald and Daniel Mason, cornetist and trombonist; Dorothy Bull, soprano; Ruth Hostetter, pianist; Blanche Kesler, reader.

WCCO, Minneapolis-St. Paul, Minn. (416.4), 11 a. m., Plymouth Congregational church; 4:10 p. m., House of Hope Presbyterian church; 8:15, Atwater Kent program, WEA F; Mabel Garrison, soprano; 9:20, classical concert.

WDAF, Kansas City, Mo. (365.6), 4-5 p. m., program, Liberty and Pantages theaters; 5-5:30, Sunday school lesson, Dr. Walter L. Wilson.

WEBH, Chicago, Ill. (370.2), 7-9 p. m., artist program.

WENR, Chicago, Ill. (266), 2-4 p. m., classical program; Rauland trio; Russell Hendrickson, cellist; C. T. Norum, tenor; 9:30-11:30, All-American Pioneers; piano and vocal selections.

WFAA, Dallas, Texas (475.9), 8-4 p. m., Sunday hour for farmers; 6:30-7:30, Radio Bible class, Dr. William M. Anderson; Bible study, Gospel song; 7:30, services, Westminster Presbyterian church, Dr. T. O. Perrin; 9-11, Little symphony orchestra, Grace Methodist Episcopal church.

WGN, Chicago, Ill. (370.2), 1 p. m., Chicago theater program; 3:30-5, Chicago Musical college concert; 9-10, Drake concert ensemble.

WHAS, Louisville, Ky. (399.8), 10 a. m., Calvary Episcopal church; 4:30-5:30 p. m., Christ church evening choral service.

WHB, Kansas City, Mo. (365.6), 9:40 a. m., Linwood Blvd. Christian church; 8 p. m., services; 11:15-1, Morrell Moore, organist.

WHO, Des Moines, Iowa (526), 11 a. m., church service; 7:30-8:30 p. m., Reese-Hughes orchestra.

WHT, Deerfield, Ill. (399.8), 12 noon, sacred dinner concert, vocal and instrumental; 12:45 p. m., Sunshine hour; 1:15, Shopper time for the kiddies; 1:30, Aerial girls' program; 1:45, boys' program; 2, Radio Copertor; 2:05, missionary program; 2:15, Fellowship program; 2:50, services, Chicago Gospel tabernacle; 5:30, Young Women's council; 6:30, concert, Tabernacle band; choir; sermon, Paul Rader; 9:30, request program; 10:30, Paul Rader and chapel staff.

WJJD, Moseheart, Ill. (302.8), 3-4 p. m., concert, Mooseheart auditorium.

WKRC, Cincinnati, Ohio (422.3), 6:45 p. m., services, Walnut Hills Christian church, Dr. J. J. Castleberry, pastor; 10, Gene Schmitt, baritone; Walter Bridge, tenor; Merrell Schwarz, baritone; Gene Perazzo, pianist.

WLB, Elgin, Ill. (302.8), 7-9 p. m., classical concert, Drake concert ensemble; Blackstone string quintet.

WLS, Chicago, Ill. (344.6), 6:30 p. m., Ralph Emerson, organist; 7-7:55, WLS Little Brown church.

WLW, Cincinnati, Ohio (422.3), 9:30 a. m., school editorial staff of Sunday school publications, Methodist Book concern; 11, services of Seventh Presbyterian church, Dr. Jesse Halsey, minister; 7:30 p. m., First Presbyterian church, Dr. McMillan, minister; 8:30, p. m., concert, H. and S. Pogue company; Walter Esberger, director; soloist, Helen Remley, soprano.

WMBB, Chicago, Ill. (250), 3-5 p. m., Trianon orchestra; Walter Duffey, Geraldine Doyle, Woodlawn theater orchestra; Billie Allen Hoff; 7-8, Trianon duo, Beatrice Teller, Joel Lay, Florence White Rush, Hazel O'Neil; 9-11, Trianon orchestra; Morey Alsang, Woodlawn theater orchestra; Harold Stokes, Charles Agne, Woodlawn theater orchestra.

WOAW, Omaha, Nebr. (529), 9 a. m., chapel service, Rev. R. R. Brown; 9 p. m., evening chapel, Immanuel Baptist church.

WOC, Davenport, Iowa (483.6), 1-2 p. m., orchestra concert; Palmer Little symphony, Erwin Swindell, conductor; vocal numbers, Paul J. Viperman, tenor; 6:30-7, services, Memorial Christian church; "The Fight for Self," Rev. Lancelot Hadaway; 8:15-9:15, Atwater Kent artists; 9:45-11:45, Palmer Little symphony, Erwin Swindell, conductor; soloists announced.

WOK, Chicago, Ill. (217.3), 6:30-8:30 p. m., WOK quartet; WOK string trio.

WOTD, Batavia, Ill. (275), 10 a. m., hymns and duets; 10:15, Bible lecture, B. F. Hollister; 9, E. S. A. choral singers; 9:15, Bible lecture, W. H. Woodley; 9:40, Violet Tait, soprano; Paul Smith, tenor; Esther Arneson, accompanist.

WOS, Jefferson City, Mo. (440.9), 9:30 a. m., Christian church; 7:30, Evangelical church.

WQJ, Chicago, Ill. (447.5), 9:30-11:30 a. m., sermon and services, Peoples' church; 3-4 p. m., concert; Clement Laskowski, tenor; Jeanette Van Lemep, mezzo-soprano; Mary Van Lemep, accompanist; 8-10, Ralph Williams and his Balbo Gardens orchestra; Alvina Becker, soprano; Madeline Ruff, concert pianist; Saida A. Ballantine artists.

WSAI, Cincinnati, Ohio (326), 2:45-4:30 p. m., address, Dr. S. Parkes Cadman; 7:45, chimes, Robert Badgley; 8, sermonette, Roger F. Babson; 8:15-9:15, Atwater Kent Radio hour, Mabel Garrison, soprano; 9:15, Union Central Life Insurance concert orchestra.

WSM, Nashville, Tenn. (262.6), 7:30 p. m., First Presbyterian church, Dr. James I. Vance.

WSUI, Iowa City, Iowa (484), 9:15 p. m., familiar hymns, William Edmondson.

Mountain Time Stations
KOA, Denver, Colo. (322.4), 10:30 a. m., solemn high mass and sermon, Immaculate Conception cathedral; 4 p. m., M. C. Marks, organist; Josephine Courtney, soloist; 7:45, Immaculate Conception cathedral.

KUOM, Missoula, Mont. (244), 9:15 p. m., Presbyterian choir; talk, Rev. Woolsey E. Couch.

Pacific Time Stations
KFWB, Hollywood, Calif. (252), 9-11 p. m., late news and Al Meyer's Aeolians; Albert Keglovich, violinist; Frank Pierce and Vic Beall, comedy songs; Frances St. George and others in Warner Brothers movie frolic.

KGO, Oakland, Calif. (361), 11 a. m., service, First Congregational church; 3:30 p. m., KGO little symphony orchestra; 7:45, First Congregational church.

KGW, Portland, Ore. (491.5), 10:55 a. m., St. Stephens Pro-Cathedral; 7:25-9 p. m., First Church of Christ Scientist.

KHJ, Los Angeles, Calif. (405.2), 6:30-7 p. m., Leigh-ton's Arcade cafeteria orchestra, Jack Cronshaw, leader; 7-7:30, organ recital, Arthur Blankely, organist; 8-10, program, Martin Music company; Ruth Pitts, soprano; John Martin, pianist; arranged by J. Howard Johnson.

KJR, Seattle, Wash. (364.4), 11 a. m., First M. E. church; 7:15 p. m., Mrs. Montgomery Lynch, organist; 7:30, First M. E. church; 9-10:30, Pusset Sound Studios & Loan association orchestra.

KNX, Hollywood, Calif. (336.9), 2-4 p. m., City of Los Angeles broadcasting by remote control from Westlake park; 7-8, First Presbyterian church of Hollywood, Rev. Stewart P. MacLennan, pastor; 8-9, Ambassador hotel concert orchestra, Josef Rosenfeld, leader; 9-10:30, program, Beverly Hills Nurseries, Russian string trio, Calmon Luboviski, concert violinist.

KPO, San Francisco, Calif. (428.3), 9:45-10:45 a. m., "Thou Art the Christ," Dr. H. P. Shaw; 5-6 p. m., Marshall W. Giselman, organist; 6-6:30, Waldemar Lind and the States restaurant orchestra; 6:35-7:30, Palace hotel concert orchestra; 8-8:30, Palace hotel concert orchestra; 8:30-10, Rudy Seliger's Fairmont hotel orchestra.

KTCL, Seattle, Wash. (305.9), 7:50-9:10 p. m., First Church of Christ, Scientist; 9:10-10:10, International Bible Students' association.

Monday, October 26

Headliners Today

Eastern 8:30	Central 7:30	Mountain 6:30	Pacific 5:30
WBZ (333.1)—Navy Day program.	9	7	6
KDKA (309.1)—Spear's Happy Home hour.			
WHAZ (379.5)—First Monthly Student program.	9:30	8:30	7:30
KFAB (340.7)—Popular artists.	10	9	8
WCCO (416.4)—Ft. Snelling Third U. S. Infantry band.			

(Continued on page 10)

STUDENTS GET TOGETHER AT WHAZ

Monday, October 26

(Continued from page 9)

Eastern	Central	Mountain	Pacific
10:10	9:10	8:10	7:10
KOA (322.4)—Excerpts from operas.			
11	10	9	8
KGO (361.2)—Educational program.			
12	11	10	9
KFWB (252)—Eskimo revue.			
KPO (428.3)—Concert.			

Monday, silent night for: CNRA, CNRC, CNRE, CNRM, CNRO, CNRR, CNRW, CNRT, CNRU, CNRV, CNRW, CNRX, CNRY, CNRZ, CNRA, CNRB, CNRC, CNRD, CNRE, CNRF, CNRG, CNRH, CNRI, CNRJ, CNRK, CNRL, CNRM, CNRN, CNRO, CNRP, CNRS, CNRT, CNRU, CNRV, CNRW, CNRX, CNRY, CNRZ, CNRA, CNRB, CNRC, CNRD, CNRE, CNRF, CNRG, CNRH, CNRI, CNRJ, CNRK, CNRL, CNRM, CNRN, CNRO, CNRP, CNRS, CNRT, CNRU, CNRV, CNRW, CNRX, CNRY, CNRZ.

Eastern Time Stations

CFCA, Toronto, Can. (356), 8:15 p. m., address, Hon. Arthur Meichen.

CKNC, Toronto, Can. (356.9), 8:30 p. m., Toronto Conservatory instrumental trio; G. Aldcroft, baritone; Vera M. Lester, soprano.

KDKA, Pittsburgh, Pa. (309.1), 8:15 p. m., dinner concert; 7:30, the lady that travels afar; 7:45, "International Art," Homer Saint-Gaudens; 9, Spear's happy home hour.

WAHG, Richmond Hill, N. Y. (315.6), 12-12:55 p. m., musical program; 7:30-1 a. m., musical program.

WBRR, New York, N. Y. (272.6), 3 p. m., Irene Klempner, soprano; 8:10, World News Digest; 8:25, Carl Park, violinist; 8:35, Bible instruction from "The Hour of God"; 8:45, Irene Klempner, soprano; 8:55, Carl Park, violinist.

WBZ, Springfield, Mass. (333.1), 6:30 p. m., organ recital, Rene Dagenals; 7:05, "The Psychology of Understanding People," Abraham Myerson; 7:30, Capitol theater orchestra; 8:30, Navy day program; navy band; 9:45, talk, Herbert Ellis; 10:05, Leo Reisman's Hotel Brunswick orchestra.

WCAU, Philadelphia, Pa. (227.6), 8 p. m., Ruth Jones, soprano; Marjory Watson, contralto; Howard McNeal, tenor; William Watson, baritone; Florence Neale, pianist; 9, Amsterdam Girl; 9:10, Philadelphia Radio minstreis; 10:10, Danny Dougherty; 10:30, Freedman & Travaline; 10:45, James Leuchter.

WCA, Detroit, Mich. (517), 6 p. m., dinner concert, Book-Cadillac hotel; 8, musical program.

WEAF, New York, N. Y. (491.5), 4-4:15 p. m., Beatrice S. Waltz, singer; 4:15-4:30, Herbert Ralph Ward, pianist; 4:30-4:45, Hazel A. Dudley, soprano; Herbert Ralph Ward, accompanist; 4:45-5, talk, Ethel Peyser; 6-7, dinner music; 7:15-8:30, piano; 7:15, Joseph Brier, baritone; 7:15-8:30, program; Strand theater; direction, Joseph Plunkett; 8:30-8:45, Colonial Aces, Hawaiian trio; 8:45-9, Tower health talk; 9-10, music, A. and P. Gypsies; 10-10:30, "Your Hour"; 10:30-11:30, Ben Bernie and his orchestra.

WEEI, Boston, Mass. (348.6), 7:15 p. m., talk, Malcolm Nichols; 7:30, musical; 8:15, Tower health talk; 9, A. and P. Gypsies; 10, Marimba band and orchestra; 11, talk, Malcolm Nichols, mayor of Boston.

WGSS, New York, N. Y. (315.6), 3-3:15 p. m., Anna Coleman Ladd, sculptor; 6-6:30, Uncle Geebee; 6:30-7:30, Premier club orchestra.

WGCP, New York, N. Y. (315.6), 3-3:30 p. m., Andy Pendleton's band; 3:30-3:45, Eva Rothberg, piano; 3:45-4, Joe Roy, harmonica soloist; 4-4:15, logue; 4:15-4:30, Richard Wallace Douglas, ukulele; songs; 4:30-4:45, Shirley Herman, songs; 4:45-5, Ona Welch, pianist; 8-8:10, Silvio de Rienzo, pianist; 8:10-8:15, health talk; 8:15-8:30, Cecil B. Kennedy quintet; 8:30-8:45, Bob Ward and the three little wards, banjoists; 9-9:45, Brookland orchestra; 10-11, Radio Shack hour; 11-11:30, Ritz orchestra; 11:30-12, Club Rodeo entertainers; 12-1, Connie's orchestra.

WGR, Buffalo, N. Y. (319), 2:30-4:30 p. m., WGR's afternoon program; 6:30-7:30, Olympic dance orchestra; 9-10, W. M. Thomas, baritone; Madame Streets, pianist; 10-10:15, Edna Hurd, soprano; 11-1 a. m., supper-dance music, Vincent Lopez, Hotel Statler dance orchestra, Harold Giesler, director.

WGJ, Schenectady, N. Y. (379.5), 6:30 p. m., dinner program, Hotel Van Curier orchestra; 7:30, "Farm Bureau Methods in Agriculture," J. Corvett; 7:30, WGJ orchestra; vocal solos; "Literary Appreciations"; "Fabre, the Homer of Insects," William L. Widemer.

WHAR, Atlantic City, N. J. (275), 7:30 p. m., fashion review, Hilda Buch; 8, Seaside hotel trio.

WHAZ, Troy, N. Y. (379.5), 9 p. m., monthly program, Rensselaer Polytechnic Institute; students' symphony orchestra.

WHN, New York, N. Y. (361.2), 6:30-6:40 p. m., Leslie McLeod, tenor; 6:40-7, "Sunshine Talks," Billy B. Van; 7-7:30, Marlboro State trio; 7:30-8, Swanee club orchestra; 8-8:05, talk, H. B. Shontz; 8:05-8:30, Roseland dance orchestra; 8:30-8:50, Perry and Russell, musicians; 11-11:30, Marsh McCurdy, organist; 11:30-12, Silver Slipper revue and orchestra; 12-12:30, Ted Lewis and his orchestra.

WIP, Philadelphia, Pa. (308.2), 6:05 p. m., dinner music, Benjamin Franklin concert orchestra, W. Irving Oppenheim, director; 7, Uncle Wip's bedtime story; dancing lesson, Miss Miller.

WJAR, Providence, R. I. (305.9), 8 p. m., Berry Spring time; 8:45, "Home Care of the Sick," Mrs. Gertrude Wilcox Harrop; 9, A. and P. Gypsies; 10, Robert W. Powers Hudson-Exsex orchestra.

WJR, Detroit, Mich. (517), 7 p. m., studio program,

Jean Goldkette, director; 9, Paige Six, Jewett Six; 11:30, Jewett Sisters, Merry Old Chief.

WLIT, Philadelphia, Pa. (394.5), 12:02 p. m., daily almanac; Stanley theater organ recital; Benjamin Franklin concert orchestra; 2, Arcadia cafe concert orchestra; 2:30, Marcella North, pianist; 4:30, Peter Nicolaidis, violinist; Magazine corner; 7:30, Dream Daddy; 9, movie review, James A. Nassau; 9:10, Stanley Hour of Music; 10:10, Arcadia cafe dance orchestra; 11, vaudeville features, Fay's Knickerbocker theater.

WMCA, New York, N. Y. (340.7), 6-6:30 p. m., Olcott Vail and his Hotel McAlpin string ensemble; 6:30-7:30, Ernie Golden and his Hotel McAlpin orchestra; 7:30-8, lullaby music; 8-8:10, democratic campaign talk; 8:10-8:30, Edward French, pianist; 8:30-8:45, Helman Weinstein, violinist; 8:45-9, Joyce Meredith, reader; 9-10, lecture, Christian Science; 10-11, Five Messner Brothers orchestra; 11-11:45, Mario Alvarez, tenor; 11:45-11:50, Jack Cohen, pianist; 11:50-11:55, Mario Alvarez; 11:55-12, Jack Cohen.

WOR, Newark, N. J. (405.2), 3:45-4 p. m., talk, Charm Magazine; 6:15-7:15, Hotel Shelton orchestra; 7:15-7:30, sports talk; 7:30-8, Al Wohlman; Frances Williams; Eddie Elkins' Ciro orchestra; 8:30-9:30, Al Reid's hour; 9:30-9:45, Edward H. Bierstadt; 10:30-11, Archie Slater's Palais D'Or orchestra; 11:30-12, New Hofbrau Haus.

WRC, Washington, D. C. (469), 10 a. m., women's hour; 12 m., Homer L. Kitt Building, organ recital; 1 p. m., Shoreham hotel orchestra; 4:30, musical program.

WREO, Lansing, Mich. (285.5), 6-7 p. m., dinner concert.

WTAG, Worcester, Mass. (268), 8 p. m., concert.

WTAM, Cleveland, Ohio (389.4), 12-1 p. m., Euclid music studio; 6-7, dinner hour music, popular entertainers; 8-11, artists, Martha Lee club school; 11-1, Guy Lombardo and his Royal Canadians.

WTIC, Hartford, Conn. (475.9), 6:30 p. m., Emil Heimbarger's Hotel Bond trio; 7:45, "Light Waves," Prof. K. S. Van Dyke; 8, dinner music; 8:30, "Colonel Roosevelt," Herbie Knott Smith; 9, Jules Klein's Hotel Statler orchestra; 9, Detroit News orchestra; 6, dinner concert; 8, Detroit News orchestra, A. & P. Gypsies.

Central Time Stations

KFAB, Lincoln, Neb. (340.7), 5:30-6:30 p. m., Buick Little symphony, Belshaw's orchestra; 8:30-10:30, Belshaw's orchestra; Max Gauchohorst, banjo and pianist; Gloomy Gus, vocal and piano numbers; Cosmopolitan club entertainers.

KFNF, Shenandoah, Iowa (266), 7 p. m., concert, Henry Field Seed company.

KFUO, St. Louis, Mo. (545.1), 8 p. m., "Be Diligent in Service," Rev. P. G. Prokopy.

KFVE, University City, Mo. (420), 6:30 p. m., amusement review, Romaine Filding; 10, Katherine Elcher, H. W. Bromfield, vocalists; Forrest Alcorn's Collegians.

KMA, Shenandoah, Iowa (252), 9-11 p. m., chimes, William Howie; Bobbie Biddle, 6 year old singer, clog dancer; program, Peter Kloman, baritone; Hazel Stage-rock, accompanist; Russian string quartet; 10:30, Skyrocket frolic, George Osborn's Skyrocket orchestra.

KBPC, Houston, Texas (296.9), 5:30 p. m., Uncle Judd's Kiddies' hour; 7:30, Records' Ramblers, dance orchestra; 8:30, Kiwanis glee club, Ellison VanHoose, director; Mrs. Harry McLean, accompanist.

KSD, St. Louis, Mo. (545.1), 9 p. m., program; 10, Dutch Master Cigar hour.

KTHS, Hot Springs National Park, Ark. (374.8), 9-9:45 p. m., classical and ballad selections, New Arlington orchestra, Lon Chassy, director; Meyer-Davis brass quartet; 9:45-10, old favorites, Louis Culp, organist; 10-11, frolic, Rainbow Garden-555 entertainers.

KYW, Chicago, Ill. (535.4), 1 p. m., Joska DeBabary and his orchestra.

WAMD, Minneapolis, Minn. (243.8), 6 p. m., George Osborn's concert orchestra; 7, "A Trip Around the World—Russia," Peter Kloman, baritone; Hazel Stage-rock, accompanist; Russian string quartet; 10:30, Skyrocket frolic, George Osborn's Skyrocket orchestra.

WBAP, Fort Worth, Texas (475.9), 7:30-8:30 p. m., artists, Texas Women's college; 9:30-10:45, Ward's Trail Blazers; 11-12, Majestic theater artists.

WCCO, Minneapolis-St. Paul, Minn. (418.4), 12 m., Donaldson's orchestra; 5:30, children's hour; 6:45, F. and R. family; 7:30, "Teamwork in Social Service," Mrs. E. L. Carpenter; 7:45, "Poultry Raisings"; 8, Third U. S. Infantry band; 9, Gordon Cooke ensemble, Meta Ashwin Birmingham.

WDAF, Kansas City, Mo. (365.6), 3:30-4:30 p. m., Star's string trio; 6-7, C. M. Ragon, organist; Tell-Me-a-Story Lady, piano ensemble; 8-9:30, Fred Hamman's town with WDAF; 11:45-1, Merry Old Chief; Carl Nordberg's Plantation players; Charles Dornberger's orchestra; Ted Meyn, organist.

WFAA, Dallas, Texas (475.9), 12:30-1 p. m., Gordon Bishop, pianist; 6:30-7:30, Artie Collins and his orchestra; 8:30-9:30, Sears-Roebuck Agricultural Foundation program.

WGN, Chicago, Ill. (370.2), 12:40 p. m., Drake concert ensemble, Blackstone string quintet; 2:30, artist series, Lyon & Healy; 3:30-4:15, tea time music, Marshall Fields tea room orchestra; 6:30-7, Drake concert ensemble, Blackstone string quintet.

WHAD, Milwaukee, Wis. (278), 6-7 p. m., Bill Bennings Milwaukee Athletic club orchestra; 8-10, Marquette university studio program.

WHAS, Louisville, Ky. (399.8), 4-5 p. m., program, Harry S. Currie; fashion talk, Peggy True.

WHB, Kansas City, Mo. (365.6), 2-3 p. m., Sweeney Radio string trio; 7-8, Glenn Durrell's Sweeney Radio orchestra.

WHO, Des Moines, Iowa (526), 7:30-8 p. m., Drake university conservatory of music; 8-9, faculty, Drake conservatory of music; 11-12, Corn Sugar orchestra.

WJAD, Waco, Texas (352.7), 8:30-10 p. m., Barton's Dvanshine stunt program.

WKRC, Cincinnati, Ohio (422.3), 6 p. m., Alvin Roehr's Hotel Alms orchestra; 10, Post-Rudolph Wulitzer popular hour, Freda Stoll's orchestra; 11, American Legion program; 12, theatrical stars, Wesley Helvey's Troubadours.

WLIB, Elgin, Ill. (302.8), 7-8 p. m., dinner concert, Drake concert ensemble; Blackstone string quintet; 9-10, Fred Hamm's orchestra; organ recital; 10-11, Jack Chapman's and the Blackstone hotel dance orchestra; jazz artists; 1-2 a. m., Jack Chapman's and the Blackstone hotel dance orchestra; jazz.

WLW, Cincinnati, Ohio (422.3), 12-15 p. m., service, Rev. Geo. Kase; 4, student recital; 7, dinner hour concert, Gibson hotel orchestra, Robert Visconti, director; 8, Times-Star concert, Times-Star orchestra, William Kopp, director; Howard Hafford, Carl Wunderle, soloists.

WMAQ, Chicago, Ill. (447.5), 4 p. m., mothers in council; 4:30, Glenn Dillard Gunn School of Music; 6, Chicago theater organ recital; 6:30, Hotel LaSalle orchestra.

WOAW, Omaha, Neb. (526), 6 p. m., Phyllis Griswold, organist; 6:30, popular song period, Lillian Madson; 7, Randall's Royal Fontenelle orchestra; 9, Skeen trio; 10, orchestra.

WOK, Chicago, Ill. (217.3), 12-2 p. m., Sandy Meek, tenor; Harry Sosnik, pianist; Jimmy Wolfe, baritone; Banks Kenyon, organist; LeRoy Nord, pianist; 6-1, Jimmy Watson, baritone; Harriet Lee, contralto; Harlan Sinalka, violinist; Ada Allen, soprano; Paul Small, tenor; Jimmy Cairns, tenor; Lew Butler, baritone; Harlan Merrill, musical saw soloist; Harry Sosnik, pianist; Sandy Meek, tenor.

WOS, Jefferson City, Mo. (440.9), 8 p. m., musical program, Christian college.

WSAI, Cincinnati, Ohio (326), 8 p. m., A. and P. Gypsies; 9, Charles Gregory, flutist; Richard Gray, baritone; Austin Brothers.

WSB, Atlanta, Ga. (428.3), 8 p. m., Atlanta Billmore Salon orchestra; 10:45, Dixie spirituals.

WSMB, New Orleans, La. (319), 8:30-10:30 p. m., Dixie Novelty orchestra, St. Charles theater orchestra, Strand theater orchestra.

WSUI, Iowa City, Iowa (484), 12:30 p. m., "Trends in Education"; 7:30, college of the air, Mahan, Mott, Shimek, Reuter; 9, Mrs. Preston C. Coast, organist.

Mountain Time Stations

KFAU, Boise, Idaho (278), 8 p. m., program, Mrs. B. A. Delano, director.

KFWA, Ogden, Utah (261), 5-6 p. m., Orden Radio Dealers program; 9-10, musical program, Fashion shop.

KOA, Denver, Colo. (322.4), 6:30 p. m., Herbert White and his Silver State orchestra; 8, scientific football, Tom McNamara; 8:10, studio program, works of Richard Wagner; KOA orchestra; Elsa Wefling Welker, L. Will Welker; Navy day address, Dr. M. H. Ames; "The Mental Health Clinic and the Community," Dr. Franklin G. Ebaugh, director; George Kief, pianist.

KOB, State College, N. M. (348.6), 7:30-8:30 p. m., "Spring and Summer Gardens," Prof. Fite; "Agricultural Price Situation in New Mexico," Mr. Haurter.

Pacific Time Stations

KFOA, Seattle, Wash. (454.3), 6:45-8:15 p. m., Sherman, Clay and company program; 8:30-10, Times studio program.

KFPG, Hollywood, Calif. (238), 9 a. m., Dad's hour with Dad King; 5-6 p. m., home hour with Georgia Simmons and neighborhood children; 8-9, Maggie O'Shea, the blamey girl, and her vaudeville entertainers; 9-10, Hollywood orchestral quartet, Eureka Douglas, violinist; Elizabeth Marion, violinist; Bernice Neale, cellist; Ruth Chambers, soprano and pianist; David Stuart, baritone.

KFWE, Hollywood, Calif. (252), 5-6 p. m., children's hour, Big Brother of KFWB; 6:30-7, program, E. P. James of Altadena featuring Bill Hatch and Ray Kellogg, jazz twins; 7-7:30, Radio question and answer period, K. G. Ormiston, technical editor; 7:30, microphone brevities; 8-9, program, Star Motor Car company, Million Dollar Four orchestra, Sol Hoopii's Junior Hawaiian trio, Frances St. George, jazzmania girl; 9-11, the Radio Review, featuring Bob Mayo's orchestra, Lee Kent and tenorship; Le Roy Kulberg, shiek of the uke; Salvino Bianco's string trio, Rogers' Hawaiian trio and others.

KGO, Oakland, Calif. (361), 11:30-1 p. m., luncheon concert; 3-4, program, Wiley B. Allen company; 6-7, dinner concert, Wiley B. Allen company studio; 8, "Physical Culture for the Family," Hugh Barrett Hobbs; Talks on Constructive Selling," B. J. Williams; "Chats About New Books," Joseph Henry Jackson; "It Pays to Analyze Character," Roscoe D. Wyatt; "The Importance of Proper Foods in Daily Life," Prof. M. E. Jaffa; "Government," Dr. Katharine Rodgers Adams.

KGW, Portland, Ore. (491.5), 12:30-1:30 p. m., Rose City trio; 8-9, concert; 9-10, Hudson and Essex orchestra.

KIR, Seattle, Wash. (384.4), 7-8:30 p. m., Sears-Roebuck company studio program; 8:30-10, Post Intelligencer studio program; 10-11, Gordon Kilbourne and his orchestra.

KNX, Hollywood, Calif. (336.9), 5:30-6:15 p. m., Wulitzer pipe organ studio, Town Tattler; 8:15, travel talk, W. F. Alder; 6:30-7, Atwater Kent Radio orchestra, Paul Finstein, leader; 7-7:30, Mutual Motors mirth contest; 7:30-8, program, Columbia Out-fitting company; 8-9, program, L. V. Stockwell company; 9-10, KNX feature program; 10-11, Goodrich Silvertown Cord dance orchestra; Lilyan May Chalmers, contralto; 11-12, Ray West, Coconut Grove dance orchestra from Ambassador hotel.

KPO, San Francisco, Calif. (428.8), 6:40-7 p. m., Waldemar Lind and the States restaurant orchestra; 7-7:30, Rudy Seiger's Fairmont hotel orchestra; 8-8:45, Uda Waldrop, organist; 8:45-9, talk, Wiley Winsor; 9-10, concert program, Uda Waldrop; 10-11, Waldemar Lind and the States restaurant orchestra.

KWSC, Pullman, Wash. (348.6), 7:30-9 p. m., Harlette Metz, soprano; Frances Primo, pianist; Raymond Howell, violinist; "Chrysanthemums," F. L. Overley; "A Plan for Compulsory Moral Training for Children," Father Carl Philipp; "Eliminating Dry Flock Ewes," C. M. Hubbard.

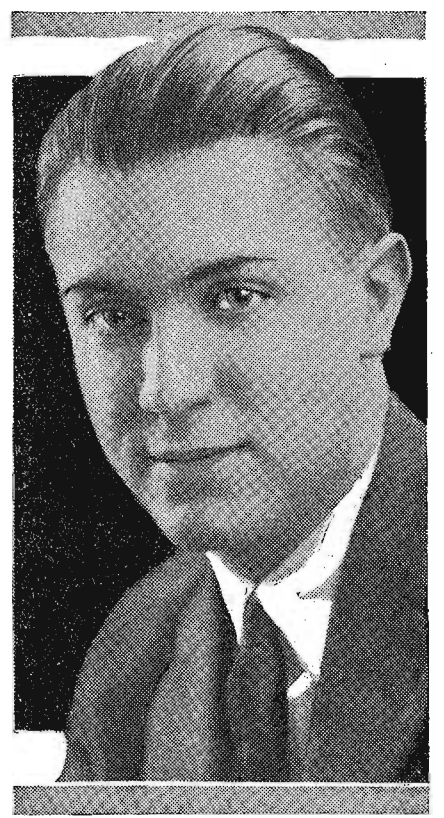

Witter Cook is not only the leading man of the WGY players but is also a promising young author and has already produced several plays at WGY.

WCX, Detroit, Mich. (517), 6 p. m., dinner concert, Book-Cadillac hotel; 10, The Red Apple club.

WEI, Boston, Mass. (348.6), 7:15 p. m., talk, Malcolm Nichols, mayor of Boston; 7:30, music; 7:45, Annetto Hughes, soprano; 8, program, WEAF; 8:30, Gold Dust Twins; 9, Eveready hour; 10, "Auction Bridge," WEAF.

WGSS, New York, N. Y. (315.6), 3-3:15 p. m., interview, Charles LeMaire; 6-6:30, Uncle Geebee; 7-8, Arrowhead Inn orchestra; 9-10, Navy day program; 10:30-11:30, Arrowhead Inn orchestra.

WGCP, New York, N. Y. (315.6), 3-3:15 p. m., Nita Osborne and Eddie Meredith, songs; 3:15-3:30, Silvio de Rienzo, pianist; 3:45-4, Ona Welch, pianist; 4-4:30, Sam Silver and his troubadours; 4:30-4:45, William J. Rietz, songs; 4:45-5, Della BJordan, baritone.

WGR, Buffalo, N. Y. (319), 2:30-4:30 p. m., WGR's afternoon program; 6:30-7:30, Vincent Lopez, Hotel Statler dance orchestra, Harold Giesler, director; 8-11, jointly with WEAF, Gold Dust Twins, Eveready hour.

WGJ, Schenectady, N. Y. (379.5), 6:30 p. m., Hotel VanCurier orchestra; 7:30, "Effect of Electron Discovery on Scientific Theory," Prof. Peter I. Wold; 7:45, Ollie Yettru, pianist; Peter Schmidt, clarinetist; 8:15, Steinway series; orchestra program; Fraser Gange, baritone; piano recital, Josef Hofmann; 10, Navy day program; 10:30, W. Spencer Tupman's Hotel Mayflower orchestra, WRC.

WHAR, Atlantic City, N. J. (275), 7:30 p. m., book review, Mrs. James Lord; 8, Seaside hotel trio; 11:15, Strand theater organ recital.

WHN, New York, N. Y. (361.2), 12:30-1 p. m., Marsh McCurdy, organist; 2:15-3:15, overture and vaudeville, Loew's State theater; 3:15-4:30, Lexington theater orchestra; 4:30-4:45, Uncle Robert and his pals; 7-7:30, Iceland orchestra; 7:30-8, Will Oakland's Chateau Shanley; 11-11:30, Caravan club orchestra; 11:30-12, Rodeo club orchestra; 12-12:45, Club Kentucky revue and orchestra.

WIP, Philadelphia, Pa. (308.2), 6:05 p. m., Joe Ray and the California Nighthawks; 7, Uncle Wip; 8, Elliott Lester, dramatic critic; 8:15, talk, George H. Biles; 8:30, recital, School of Musical Art; 10:30, Navy day program; 11, Club Pagoda orchestra, Charles Verna, director.

WJAR, Providence, R. I. (305.9), 7:05 p. m., Providence Billmore hotel concert orchestra; 7:30, musical program; 8:30, Gold Dust Twins; 9, Eveready hour.

WJR, Detroit, Mich. (517), 7 p. m., studio orchestra, Jean Goldkette, director; 9, Jean Goldkette's serenaders.

WLIT, Philadelphia, Pa. (394.5), 11 a. m., organ recital; Stanley theater; recital; Arcadia cafe concert orchestra; 2:30, Charlotte King, reader; Iris Virginia Gruber, soprano; Marcella North, pianist; 7:30, Dream Daddy's bedtime stories.

WLWL, New York, N. Y. (288.3), 8 p. m., question box, Rev. James Gillis; 2, Catholic study club; vocal and instrumental numbers.

WMCA, New York, N. Y. (340.7), 6-6:30 p. m., Olcott Vail and his Hotel McAlpin string ensemble; 6:30-7, Frank Gibbilla's Red Lion Inn orchestra; 7-8, Jack Wilbur's personalities; 8-8:10, democratic campaign talk; 8:10-8:30, Theo. Alban, tenor; 8:30-9, Shepard Knapp music; 9-9:30, Ruth Friedman, pianist; 9:30-9:45, Catherine V. Harvey, soprano; 11-12, Ernie Golden and his Hotel McAlpin orchestra.

WOR, Newark, N. J. (405.2), 6:15-6:30 p. m., sports talk; 6:30-7, Man in Moon; 7-7:30, Hotel Shelton orchestra.

WRC, Washington, D. C. (469), 10 a. m., women's hour; 12 m., Otto F. Beck, organist; 1 p. m., New Willard hotel orchestra; 7, Shorchan hotel orchestra; 8, Wurlitzer music; 8:15, orchestra, William Mengelberg, director; Josef Hofmann, pianist; 9:45, to be announced; 10:30, W. Spencer Tupman and his Hotel Mayflower orchestra.

WREO, Lansing, Mich. (285.5), 6-7 p. m., dinner concert; 8:15, Reo Motor Car company band; Reo Motor Car company band glee club; Mrs. Beulah Clark Northrop, pianist.

WTAG, Worcester, Mass. (268), 8-8:30 p. m., Ross Gorman and his Earl Carroll Vaudeville orchestras; 8:30-9, vocal selections, "Long and Broad"; 9-10, Eveready hour; 10-11, WEAF Grand Opera company.

WTAM, Cleveland, Ohio (389.4), 12-1 p. m., lunch hour music; 6-7, Hotel Hollenden studio.

WTIC, Hartford, Conn. (475.9), 6:30 p. m., Hub Restaurant trio; 7, Robert Mercer, baritone; 8, music of the American; 8:30, Gold Dust Twins; 9, Eveready hour; 10, Barber Shop Ballad concert.

WWJ, Detroit, Mich. (352.7), 12:05 p. m., Jules Klein's Hotel Statler orchestra; 3, Detroit News orchestra; 6, dinner concert; 8, concert from WEAF.

Central Time Stations

KFAB, Lincoln, Neb. (340.7), 5:30-6:30 p. m., Buick Little symphony, Belshaw's orchestra; 8:30-10:30, musical program, University of Nebraska.

KFDM, Beaumont, Texas (315.6), 8-10 p. m., musical program.

KFMM, Carleton, Minn. (337), 9:30-10 p. m., Frederick Lorke Lawrence, pianist.

KFNF, Shenandoah, Iowa (266), 7 p. m., concert, Villisca, Iowa, B. R. Mayhew, director.

(Continued on page 11)



Freida Stoll, coloratura soprano, who entertains regularly at WGES, Chicago, has a voice which has been complimented for its Radio transmission.

SLEEPY HOLLOW TRIO FROM KDKA



Jimmy Agne is the popular entertainer at WEAF who stopped the show recently at a Cleveland theater when he appeared in public

Tuesday, October 27

(Continued from page 10)

KFVE, University City, Mo. (240), 6:30 p. m., amusement review, Romaine Fielding; 10, concert, popular music, Brunswick-Balke-Collider company; Orchestra Romaine.

KLDS, Independence, Mo. (441), 8 p. m., Navy day program; Ona Goodrich, soprano; Leith Stevens, pianist; Carolina Schmidt, violinist; Eweda Faulkner, contralto; Thomas Martinson, accompanist; address, Congressman Harry B. Hawes.

KMA, Shenandoah, Iowa (252), 6-7 p. m., May Flower orchestra; June and Jim Taylor, Bobbie Ross; flower talk, Lina Ferguson; 9-11, May's Mandolin musicians.

KPRC, Houston, Texas (296.9), 7:30 p. m., Billie Mack and his orchestra; 8:30, Jane Cammack, soprano; W. A. Stubbelfield, accompanist; 9, J. D. Brightwell, pianist; J. Sleser, contralto.

KSD, St. Louis, Mo. (545.1), 8:45 p. m., Merchants and Manufacturers annual dinner, addresses, Hon. Nicholas Longworth, Rear Admiral Coontz, U. S. N. **KTHS, Hot Springs National Park, Ark. (374.8),** 9-9:45 p. m., dance music, 10-piece New Arlington orchestra; 9:45-10:15, novelty numbers, whistling, bird imitations, fiddlin', Caddo Academy artists; 10:15-11, Meyer-Davis dance orchestra, Lon Chassy, director.

KYW, Chicago, Ill. (535.4), 11:35 a. m., table talk, Mrs. Anna J. Peterson; 2:35-4 p. m., afternoon frolic; 6:35-7, children's bedtime story, Uncle Bob; 7-7:30, dinner concert, Congress hotel; 8-8:30, Paul Hyland, banjoist; Joseph F. Murphy, vocalist; 8:20-8:45, "When I Was a Boy," O. E. Bradfute; 8:45, music; 10-11:30, evening at home.

WBAP, Fort Worth, Texas (475.9), 7:30 p. m., Carolyn Bell McFarland; 9:30-10:45, Anne Strathsee, Mrs. Helen Phifer Barnes, classical program.

WBBM, Chicago, Ill. (226), 5:30-6 p. m., Kiddies' Joy-Digger club; 6-10, Samovar orchestra; staff artists; Fair and Warner duo; Torrid two; banjo and cornellists; Blue deuces; George Marbach, tenor; string quartet; 10-12, Donmarque orchestra; Bert Davis; Bernard Gansson, violinist; Lewon comedy four; Honky-Tonk Gloom, harpist; Joseph Raieff, concert pianist; Leona Hayes, chorus.

WCBD, Zion, Ill. (344.6), 8 p. m., organ; quartet on celestial bells; Prof. D. Inman, soprano; E. B. Paxton, baritone; Florence Farrar, contralto; Alice Peters, violinist; F. Farrar and E. B. Paxton, duet; Edwin Sash, pianist; Mrs. E. Paxton, reader.

WCCO, Minneapolis-St. Paul, Minn. (416.4), 12 m., Dick Long's Dayton trio; 5:30, children's hour; 6, Chadbourne's Nicollet hotel orchestra; 7:30, WEAF, Gold Dust Twins, Eveready hour; Auction Bridge lesson; 10:05, Third Battalion Naval Reserve band.

WDAF, Kansas City, Mo. (365.6), 3:30-4:30 p. m., Star's string trio; 6-7, address; Tell-Me-a-Story Lady; Trianon ensemble; 11:45-1, Merry Old Chief; Plantation players; Charles Dornberger's orchestra.

WEBB, Chicago, Ill. (370.2), 7-8 p. m., Oriole orchestra; Lydia Lochner, contralto; Uptown theater; 9-10, Oriole orchestra; songs, Paul Small; 11-1 a. m., Oriole orchestra; Sandy Meek, tenor; Harry Sosnick, accompanist; Jack Penewell, twin guitarist; songs, Paul Small.

WENR, Chicago, Ill. (266), 6-7 p. m., dinner concert; Rauland trio; twin piano numbers, vocal selections; 8-10, popular program; Philip Millville, baritone; Al Tweed, Loretta Giles, popular songsters; Burt Davis, the Clown of the Air.

WFAA, Dallas, Texas (475.9), 12:30-1 p. m., Beaumont band; 6:30-7:30, Tokio Royal orchestra; 8:30-9:30, Southern Methodist university; 11-12, Senior Enrique Rasopio, violinist; 12-1 a. m., Palace theater.

WGN, Chicago, Ill. (370.2), 2:30 p. m., artist series, Lyon and Healy; 3, talk, speaker of Navy league; 3:30-4:15, tea time music, Marshall Fields tea room orchestra; 6:30-7, Drake concert ensemble, Blackstone string quintet; 8-9, WGN string trio; 10-11, Jack Chapman's orchestra; Blackstone hotel dance orchestra.

WHAD, Milwaukee, Wis. (278), 6-7, p. m., Bill Benning's Milwaukee Athletic club orchestra.

WHAS, Louisville, Ky. (399.8), 4-5 p. m., special program, Harry S. Currie; children's stories, Eleanor Huber; 7:30-9, Eddie Rosson and his orchestra; three-minute thrift talk, Liberty Insurance bank.

WHB, Kansas City, Mo. (365.6), 2-3 p. m., ladies hour program; 7-7:30, Morrell Moore, organist; 8-9:30, Mrs. Arthur G. Stannard, soprano; Mrs. Ruskie Hopkins, contralto; Turney Gibson, violinist; Mrs. John Millar, Mrs. S. V. Vodian, pianists.

WHO, Des Moines, Iowa (526), 7:30-8 p. m., Ralech quintet; 8-9, Bankers' Life trio; 11-12, Bankers' Life Little symphonic orchestra.

WHT, Deerfield, Ill. (399.8), 6-7:30 p. m., classical program; Grayling's string trio; Eleanor Gilmour, soprano; Helen Raun, pianist; John Clark, baritone; Oscar Heather, tenor; Al Carnoy, organist; Luffits period;

(288), 7:45-9:15, musical features; (399.8), 9:30, Jelke entertainers; Kitchen Klezmer Classics; Larry Shay, tenor; U. S. L. program; Al Carnoy, organist; Husk O'Hare's orchestra; 12, Pat Barnes and Al Canney.

WJLD, Mooseheart, Ill. (302.8), 6-6:30 p. m., Howard Peterson, organist; 6:30-7, Belmont trio; 8-9, program, Mooseheart children; talk, M. P. Adams; 10-11, Rushmore ensemble concert, Clarence Harper; 12-1, announced.

WKRC, Cincinnati, Ohio (422.3), 10 p. m., George Weber, tenor; Maxim Eastlyuck, Russian baritone; George Egbers, tenor; Carolyn Schlosser, reader; Tommy Reynolds and Irene Downing, popular song numbers; Gene Perazza, pianist.

WLIB, Elgin, Ill. (302.8), 7-8 p. m., dinner concert, Drake concert ensemble; Blackstone string quintet; 9-10, Fred Hamm's orchestra; organ recital; 10-11, Jack Chapman's and the Blackstone hotel dance orchestra; jazz artists; 1-2 a. m., Chapman's orchestra; Blackstone hotel dance orchestra; jazz.

WLS, Chicago, Ill. (344.6), 6:30 p. m., Ralph Emerson, organist; 8-10, WLS trio; 5:55, American Indian music.

WLW, Cincinnati, Ohio (422.3), 12-15 m., Petronella Trimbur, organist; 4 p. m., French lesson, Madame Ida Teimpidis; 7-8, Crosley Burnt Kokers; 8, Crosley feature orchestra in melody of patriotic airs, celebrating Navy day; address, Commander Jacob Kline, U. S. N.; Muscione male quartet in "Songs of the Sea"; 9, Fornica concert orchestra, William Stocess, director.

WMAQ, Chicago, Ill. (447.5), 12:45 p. m., Radio Farm school; 2, shut-in program; 4, household arts, Mrs. Elizabeth O. Hiller; 4:45, Columbia School of Music; 6, Chicago theater organ recital; 6:30, Hotel LaSalle orchestra; 8, literary sidelights, Harry Hansen; 8:40, travel talk, Clara E. Laughlin; 9, lecture, University of Chicago; 9:20, program, Mrs. Angie Montgomery.

WMBB, Chicago, Ill. (250), 7-8 p. m., Trianon duo; Beatrice Teller, Mildred Matejka, Jean Ballard, Babbi and Barr, Paul Cadieux, Hazel O'Neil, Clarence Jacobs; 9-11, Trianon orchestra; Woodlawn theater orchestra.

WOAW, Omaha, Nebr. (526), 6:30 p. m., Ed Myers and his Peony Park orchestra; 7:10, Radio review, Neal Jones; 9, program, Hannan-Van Brunt company, Ford dealers; 12, Rialto theater.

WOC, Davenport, Iowa (483.6), 5:45-6 p. m., chimes concert; 6:30-6:50, Sandman's bedtime stories; 7:30-8, Gold Dust Twins, WEAF; 8-9, WEAF Eveready hour; 9-9:30, "Auction Bridge," WEAF; 9:30-10:30, Jeanette Browbaker, soprano; Herbert Silberstein, violinist; Howard A. Carroll, tenor.

WOK, Chicago, Ill. (217.3), 12-2 p. m., Banks Kennedy, organist; Marianne Powell Babcock, soprano; Thomas B. Stephenson, tenor; Marie Dneprova, soprano; Elsie C. Stephenson, pianist; 6-7, Genevieve Barry Burman, soprano; Clement Laskowski, tenor; LeRoy North, pianist; Banks Kennedy, organist; 10-11 a. m., Kraft Harmony Boys; Bill Gay, bass; Evelyn Johnson, contralto; Jack Armstrong, violinist; Carl

Elite trio; Louise Sullivan, soprano; 10-11, Warner brothers frolic, direction Norman Manning.

KGO, Oakland, Calif. (361), 6-7 p. m., dinner concert, Wiley B. Allen company; 8, "Radio Breezes," KCB; 8:10, Navy Day program.

KGW, Portland, Ore. (491.5), 12:30-1:30 p. m., Rose City trio; 7:45-8, Oregon Bankers' association; 8:9, "Sound Investments," George H. Burr; style talk, Sage of Yamhill county; Rose City trio; 9-10, General Cord orchestra; 10-12, Indian Grill dance music.

KHJ, Los Angeles, Calif. (405.2), 6-6:30 p. m., Leighton's Arcade cafeteria orchestra, Jack Cronshaw, leader; 6:30-7:30, history story, Prof. Hertzog; weekly visit of Queen Titania and Sandman from Fairyland; Chas. Leath Hill, readings; Louis F. Klein, auto-harp and harmonium; 7:30, talk on dogs, H. M. Robertson; 8-10, program, Newbery Electric corp., Navy day program, arranged by J. Howard Johnson; 10-11, Art Hickman's Biltmore hotel dance orchestra, Frank Ellis, leader.

KJR, Seattle, Wash. (384.4), 1:15 p. m., organ recital; 2, home helps, Bernice Redington; 8:30, Puget Sound Savings and Loan association orchestra.

KM, Hollywood, Calif. (336.9), 5:30-6:15 p. m., Wurliizer pipe organ studio, Town Tattler; 6:15, travel talk, W. F. Alder; 6:30-7, Atwater Kent Radio orchestra, Paul Finstein, leader; 7-7:45, Don Clark and his LaMona ballroom orchestra; 7:45, talk on health, Dr. Robert T. Williams; 8-10, KNX feature program arranged by Town Crier; 10-12, movie night at the Ambassador, Ray West's Cocoanut Grove dance orchestra.

KPO, San Francisco, Calif. (428.3), 7-7:30 p. m., Rudy Seiger's Fairmont hotel orchestra; 8-9, Navy day; 9-10, Mona Motor Oil company; 10-11, Jack Coakley's Cabirians.

Wednesday, October 28

Eastern	Central	Mountain	Pacific
8	7	6	5
KFNF (266)—Melody Maids.			
8:30	7:30	6:30	5:30
WBAP (475.9)—Panther Hawaiian trio.			
WEAF (491.5)—Pooley Period.			
WHO (526)—Popular artists.			
9	8	7	6
KDKA (309.1)—Dry Slitz hour of music.			
WDAF (365.6)—Classical concert.			
WTAM (389.4)—Organ recital.			

Index to Farmers' Programs

Farmer Dinner Concerts

Daily Except Sunday
KFNF, 12:15-1:35 (central time).
WLS, 12 (central time).

Radio Farm School

WMAQ, 12:45 (central time); 12:10 on Friday.
WOC, 12:15-12:25 (central time).

Talks

Daily Except Saturday and Sunday
KFAU, 4 (mountain time).
KMA, 11:30-12:30 (central time).
WCCO, 7:45 (central time) Monday and Friday.
WLS, 9 (central time).
WEAR, 11:30 (eastern time).

KEY TO MARKETS AND WEATHER

b-butter; c-cattle; ch-cheese; d-dairy; e-eggs; f-fruit; g-grain; l-livestock; m-markets; p-poultry; q-quotations; r-rroad reports; s-sheep; v-vegetable; w-weather.

Stockenberg, harmonica soloist; Harriet Lee, contralto; Herman Sinaiko, violinist; Banks Kennedy, organist; LeRoy North, pianist.

WORD, Batavia, Ill. (275), 8 p. m., Webster hotel concert trio; 8:15, World News Digest; 8:30, Cosmopolitan school of music; 9, Navy league, U. S.

WOL, Chicago, Ill. (447.5), 3 p. m., "Add a Little Bran," Helen Downing; "When the Heavens Declare," Prof. Olaf A. Toftsen; 7-8, dinner concert, Ralph Williams and his Rainbo Gardens orchestra; Henrietta Nolan, violinist; Marie Dneprova, Russian soprano; Sheppard Levine, tenor; Helen Reed, accompanist; 10-1 a. m., Ralph Williams and his Skylarks; Dr. Carl Bertschinger, concert pianist; C. B. Roe, baritone; Adelaide Steeg, contralto; Jerry Sullivan, Rose Vanderbosch, soprano and pianist; Hal Lansing and his uke; Everett Onie, character reader; Frank Blasco, boy tenor; Will Rossiter, Mack Sisters, Bert Davis, Merrill Carder, June Lee, comedien; 1-2, Ginger hour with Ralph Williams.

WSAI, Cincinnati, Ohio (326), 7:20 p. m., "Navy Day," Brigadier Gen. Dion Williams; 7:45, chimes, Robert Badgley; 8, Eveready hour of music; 9-9:30, Radio Auction Bridge games; 9:30, Waldene Johnston, violinist; Hiah Clark, soprano; Mrs. Grace Baine, pianist.

WSB, Atlanta, Ga. (428.3), 9 p. m., program, Lyon and King; 10:45, Navy day program.

WSUI, Iowa City, Iowa (484), 12:30 p. m., psychology in daily life.

Mountain Time Stations

CNRR, Regina, Can. (435), 8 p. m., studio program, Mrs. H. Rowson.

KFAA, Ogden, Utah (261), 5-6 p. m., Ogden Radio artists program.

KOA, Denver, Colo. (322.4), 6:30 p. m., Herbert White and his Silver State orchestra; 7:30, News-Times concert.

Pacific Time Stations

CNRV, Vancouver, Can. (291), 8:30 p. m., Mrs. Mary Arnold, soprano; Edward Narrowsay, pianist; Caroline Steel, contralto; A. E. Knight, bass; Donald Hyslop, baritone; James Todd, accompanist; Cabaret Belmont orchestra.

KFOA, Seattle, Wash. (454.3), 6:45-8:15 p. m., Rhodes Department store; 8:30, program; 9:30-11:30, Eddie Harkness and his orchestra.

KFPG, Hollywood, Calif. (238), 9 a. m., Dad's hour, Dad King; 9:30, Sylvia Szymanski, blind cook; 5-6 p. m., home hour with Georgia Simmons and Little Billy Lord; 8-9, KFPG orchestra, Tom Mitchell, baritone; 9-10, KFPG dance orchestra.

KFWB, Hollywood, Calif. (252), 5-6 p. m., children's hour, Big Brother of KFPWB; 6:30-7, program, E. P. James of Altadena, featuring Ray Kellogg and Bill Hatch; 7, talk on golf, Howard A. Beall; 7:15, talk, Dr. W. F. Schuster; 7:30, microphone brevities; 8, "Pep" program, Kellogg Sales company; 9-10, program, H. L. Crockett Hudson-Essex company; H. L. Crockett, baritone; Paul Jones, Hawaiian guitarist;

WEAF, New York, N. Y. (491.5), 4-4:45 p. m., Ray Nichols orchestra; 4:45-5, "Before Six," Paul V. Kellogg; 6-7, dinner music, Waldorf-Astoria; 7-7:30, services, United Synagogue of America; 7:30-8, concert, United States Army band; 8-8:30, Huyler's Bon Bon Buddies; 8:30-9, Pooley Period; 9-10, "Waterman's Points of Progress—Lincoln, the Emancipator"; 10-11, Ipana troubadours; 11-12, Ben Bernie and his Hotel Roosevelt orchestra.

WEEL, Boston, Mass. (348.6), 7:30 p. m., Miss Adams, soprano; 8, Hyler's Bon Bon Buddies; 8:30, Radio Equipment company program; 9, Waterman's Points of Progress; 10, Ipana Troubadours; 11, talk.

WGSS, New York, N. Y. (315.6), 5-4 p. m., program for merchant seamen in Marine hospital; 6:30-7:30, Molzen's orchestra.

WGCP, New York, N. Y. (315.6), 3-3:15 p. m., Henry Roger, pianist; 3:15-3:30, Waller, Banks and Rafaz trio; 3:30-3:45, Frank Gallasi, songs; 3:45-4, Clarence Williams trio; 4-4:15, Ona Welch, pianist; 4:15-4:30, studio program; 4:30-4:45, Charlotte Trystmann, pianist; 8-8:10, piano solo; 8:10-8:15, health talk; 8:15-8:30, Ukulele Lon Hayes; 8:30-8:45, Heck and Jerome, songs; piano; 8:45-9, Hill Daly's Queen City quartet; 9-9:15, Sam Silver's entertainers; 9:15-9:30, William J. Kleiz, songs; 9:30-9:45, Hughie Woolford, pianist; 9:45-10, Nate Osborne and Eddie Meredith, songs; 10-10:45, Strickland's orchestra; 11-11:45, Club Richman orchestra; 12-1 a. m., Connie's orchestra.

WGR, Buffalo, N. Y. (319), 2:30-4:30 p. m., WGR's afternoon program; 9-11, jointly with WEAF, Waterman's Points of Progress; and the Ipana troubadours; 11-1 a. m., supper-dance music, Vincent Lopez Hotel Stadler dance orchestra, Harold Giesler, director.

WGY, Schenectady, N. Y. (379.5), 6:30 p. m., children's program; 6:45, Albany Strand theater orchestra, Julius Boxhorn, conductor; Floyd H. Walters, organist; 7, Book of Knowledge program; 9:30, Chamber music concert; Frederick Stock, conductor; Pola Pflisch, soloist; Lynnwood Farnham, organist, WRC.

WHN, New York, N. Y. (361.2), 2:15-2:45 p. m., Jimmy Clarke and his entertainers; 7:30-9, Caravan club orchestra; 10-10:30, Roseland dance orchestra; 11-11:30, Silver Slipper orchestra; 11:30-12, Ted Lewis and his orchestra; 12-12:30, Harry Richman and his Club Richman entertainers.

WIP, Philadelphia, Pa. (508.2), 6:05 p. m., dinner music; Benjamin Franklin concert orchestra; W. Irving Oppenheim, director; 7, Uncle Wip.

WIAR, Providence, R. I. (305.9), 7:30 p. m., U. S. Army band; 9, Waterman's Points of Progress; 10, musical program.

WJR, Detroit, Mich. (517), 7 p. m., studio program; 9, Burroughs hour; 11:30, Jewett Jesters, Morry Old Chief.

WKAQ, San Juan, P. R. (340.7), 7-9 p. m., municipal band, Prof. Manuel Tizol, director.

WLIT, Philadelphia, Pa. (394.5), 12:02 p. m., daily almanac; Stanley theater organ recital; Arcadia cafe concert orchestra; 2, Arcadia cafe concert orchestra; 2:30, Mary V. Shoop, pianist; Marcella North, accompanist; 4:30, Nettie Sauer, soprano; Stanley Lentz, violinist; 7:30, Dream Daddy's bedtime stories; 10, Arcadia cafe dance orchestra.

WMCA, New York, N. Y. (340.7), 6-6:30 p. m., Olcott Vail and his Hotel McAlpin string ensemble; 6:30-7:30, Ernie Golden and his Hotel McAlpin orchestra; 7:30-7:40, Catherine V. Harvey, soprano; 7:40-8, democratic campaign talk; 8-9, services, Northminster church; 10:30-11:30, Andy Ascutto's Paragon dance orchestra; 11:30-11:45, Jack Sulth, whispering baritone.

WOR, Newark, N. J. (405.2), 2:45-3 p. m., talk, Dr. George W. Little; 6:15-7, Hotel Shelton orchestra; 7-7:15, sports talk.

WRC, Washington, D. C. (469), 10 a. m., women's hour; 12 m., organ recital, Homer L. Kitt building; 1 p. m., Hotel Washington orchestra; 3, unveiling of statue to San Martin; address, Ambassador of Argentina; address, President Coolidge; invocation, Archbishop Michael J. Curley; benediction, Rev. James B. Freeman; 4:30, musical program.

WREO, Lansing, Mich. (285.5), 6-7 p. m., dinner concert.

WTAG, Worcester, Mass. (266), 8 p. m., concert.

WTAM, Cleveland, Ohio (389.4), 12-1 p. m., Buell Music studio; 6-7, Guy Lombardo and his Royal Canadians; 8-9, Willard studio concert program; 9-10, organ recital; 10-11, Willard Ladies' ensemble; 11-1 a. m., Guy Lombardo and his Royal Canadians.

WTIC, Hartford, Conn. (475.9), 6:30 p. m., Hotel Bond trio; 10, Bill Tasillo's Cinderella ballroom orchestra.

WWJ, Detroit, Mich. (352.7), 12:05 p. m., Jules Klein's Hotel Stadler orchestra; 3, Detroit News orchestra; 6, dinner concert; 8, News orchestra; 9, program from WEAF.

Central Time Stations

CNRW, Winnipeg, Can. (384.4), 8:10 p. m., Fort Garry hotel concert orchestra; 9:45, supper-dance program, Al Kilgour.

KFAB, Lincoln, Nebr. (340.7), 5:30-6:30 p. m., dinner hour concert; 8:30-10:30, Margaret Mosher, violinist; Floyd Mosher, pianist; Belshaw's orchestra; Ralph Hall, banjoist, ukulele solo, vocal.

KFMX, Carleton, Minn. (337), 9-10 p. m., musical program.

KFNF, Shenandoah, Iowa (266), 7 p. m., concert, Melody Maids, Irene Ross.

KFRU, Columbia, Mo. (499.7), 8 p. m., musical program, faculty and students, Stephens College Conservatory of Music; sextet; Olivia Noel, pianist; Basil Gauntlett, pianist; Katherine Farrar, vocalist; Valborg Leland, violinist; violin duet; string ensemble; E. L. Can, vocalist; Alma Bieber, vocalist.

KFUO, St. Louis, Mo. (543.1), 9:15 p. m., "The Gospel Still Victorious Over Modern Unbelief," Rev. Joseph Frenz.

KFVE, University City, Mo. (240), 6:30 p. m., amusement review, Romaine Fielding; 10, Paul and Jack Snyder, entertainers; Orchestra Romaine.



Irma Carpenter is the soprano member of the Sleepy Hollow Trio which will give a classical program Thursday at KDKA, Pittsburgh.

SPECIAL ARGENTINA-UNITED STATES

Index to Popular Concerts

TABULATED below is a time table of the stations giving popular concerts this week. Stations are divided into the four different standard times in use. The hours are given in the kind of time in use at each listed station. By using this table as an index and referring to the complete programs below, full information will be obtained.

Popular

Eastern Time Stations

Saturday, October 24: 8:30, WGBS; 8:45, WFAF; 9, WFAF, WGBS, WNYC; 9:30, WGBS; 10, WREO; 10:30, WFAF, WRC; 10:45, WFAF.

Monday, October 26: 7:30, WHN; 7:45, WAHG; 8, WGBS; 8:30, WOR; 8:45, WAHG; 9, WCAU, WFAF, WGR, WOO; 9:15, WAHG; 9:30, WGR, WHAZ; 10, WGR, WMCA; 11, WLIT; 11:30, WHN; 12, WAHG; 1, WAHG.

Tuesday, October 27: 7, WMCA; 8, WEAR; 8:30, WMCA; 9, WBZ, WEAR; 11, WHN; 11:30, WHN.

Wednesday, October 28: 7:30, WAHG, WEEL, WHN; 7:45, WAHG; 8, WAHG, WEBJ, WEEL, WGCP, WMCA; 8:15, WAHG, WGCP; 8:30, WEBJ, WGCP; 9, WEBJ, WGCP, WNYC; 9:30, WAHG; 9:45, WAHG, WCAU; 10, WGCP; 11, WHN.

Thursday, October 29: 7:30, WFAF; 8, WCAE, WCTS, WFAF, WFL, WMCA; 8:15, WBZ; 9:30, WCAU; 10, WHN, WNYC; 10:20, WBZ.

Friday, October 30: 7:30, WEEL; 7:45, WAHG, WGY; 8, WGCP, WJR; 8:30, WEEL, WGCP, WHN; 9, WGR; 9:15, WBZ, WGCP; 9:30, WAHG, WHN; 9:45, WGCP; 10, WLIT; 10:30, WHN, WLIT; 11:30, WHN, WTIC.

Central Time Stations

Saturday, October 24: 6:30, WFAA; 7:20, WLS; 7:30, WMBB; 8, WBBM, WENR, WLS, WMAQ, WTAS; 8:30, WGN, WLS; 9, KPRC, WBBM, WENR, WGN, WMBB, WTAS; 9:30, WEBB; 10, KFVE, WBBM, WMBB, WOK, WQJ, WTAS; 10:30, WEBB; 11, KOIL, WBBM, WLS, WOAW, WOK, WQJ; 11:30, WEBB; 11:45, WDAF; 12, WBBM, WEBB, WENR, WOK, WQJ, WSAI; 12:30, WBBM, WEBB, WENR, WOK, WQJ, WSAI; 12:30, WDAF, WOK, WQJ; 1, WBBM, WENR, WQJ.

Sunday, October 25: 7:30, KOIL; 8, WBBM, WTAS; 9, WBBM, WTAS; 10:15, KTHS, WTAS; 11, KTHS, WTAS; 12, WBBM.

Monday, October 26: 6, WBBM; 6:30, WFAA, WOAW; 6:45, WCCO; 8, WTAS; 8:30, KFAB, WOK; 9, WMBB, WOK; 9:25, KTHS; 9:30, KFAB; 10, KFAB, KFVE, WMBB, WOK, WTAS; 10:30, WHT; 11, KOIL, WHO, WOK; 11:45, WDAF; 12, WHT, WOK.

Tuesday, October 27: 6, WOAW; 7:30, KPRC, WBAP; 8, WBBM, WSB, WTAS; 9, WBBM, WMBB, WTAS, WOAW; 9:30, WOAI; 10, KFVE,

WBBM, WHT, WMBB, WOK, WQJ, WTAS; 10:15, WSB; 10:30, WGN; 11, KOIL, WBBM, WFAA, WMC, WOK, WQJ; 11:45, WDAF; 12, WFAA, WHT, WOAW, WOK, WQJ; 1, WQJ.

Wednesday, October 28: 7, KFNE, WLS; 7:30, KOIL, WBAP, WHO; 8, WBBM, WTAS; 8:30, KFAB, WHO; 9, KPRC, WBBM, WHO, WMBB; 9:30, KFAB, WBAP, WTAS; 10, KFAB, KFVE, KYW, WMBB, WOK, WQJ, WTAS; 10:30, KYW, WGN, WHT; 10:45, WSB; 11, KYW, WOK, WQJ, WSAI; 11:45, WDAF; 12, KYW, WBBM, WHT, WOK, WQJ; 1, WBBM, WOK, WQJ.

Thursday, October 29: 6:30, WFAA; 7, WOC, WSAI; 7:30, WBAP; 8, WBBM, WHAD, WTAS; 9, KMA, WBBM, WHAD, WMBB, WTAS; 9:30, KTHS, WOAI; 10, KMA, KYW, WBBM, WMBB, WOK, WQJ, WTAS; 10:02, WLW; 10:30, WGN, WHT; 10:45, WSAI; 11, KOIL, WBBM, WFAA, WOC, WOK, WQJ, WTAS; 11:20, WLW; 11:45, WDAF; 12, WHT, WOK; 12:15, WLW, WQJ; 1, WQJ.

Friday, October 30: 6:30, WFAA; 8, WBBM, WLS, WOC, WTAS; 9, WBBM, WDAF, WHAD, WOAW; 9:30, WTAS; 9:45, WLS; 10, KFVE, KYW, WOK, WQJ; 10:30, KYW, WGN, WHT; 10:45, WSAI; 11, KOIL, WMC, WOK, WQJ; 11:30, KYW; 11:45, WDAF; 12, WHT, WOK, WQJ; 1, WQJ.

Mountain Time Stations

Wednesday, October 28: 10, KFVA.
Friday, October 30: 10, KFVA.

Pacific Time Stations

Saturday, October 24: 8, KFVB, KNX; 9, KNX, KPO; 10, KFVB, KFI; 11, KNX; 11:30, KHJ, KTCL; 12, KNX; 12:30, KHJ; 1, KNX; 1:30, KHJ.

Sunday, October 25: 8, KHJ; 9, KFVB; 10, KFVB.

Monday, October 26: 9, KNX; 10, KFVB; 11, KFVB; 12, KFVB.

Tuesday, October 27: 8, KFVB, KNX; 9, KNX, KPO; 10, KFVB, KNX; 11, KFVB.

Wednesday, October 28: 8, KGW, KPO; 9, KFVB, KNX; 10, KNX; 11, KFVB; 12, KNX.

Thursday, October 29: 8, KHJ; 9, KHJ, KTAB; 10, KFVB, KHJ; 11, KNX.

Friday, October 30: 8, KFVB; 9, KFVB, KHJ, KNX; 10, KFVB, KNX; 12, KFVB, KNX; 1, KNX.

WGN, Chicago, Ill. (370.2), 12:40 p. m., Drake concert ensemble, Blackstone string quintet; 2:30, artist series, Lyon and Healy; 3:30-4:15, tea time music, Marshall Fields tea room orchestra; 6:30-7, Drake concert ensemble, Blackstone string quintet; 8-9, WGN string trio; 10-11, Jack Chapman's orchestra; Blackstone hotel dance orchestra.

WHAD, Milwaukee, Wis. (278), 6-7 p. m., Arthur Richter, organist; 8-10, Wisconsin Roof Garden orchestra.

WHAS, Louisville, Ky. (399.8), 4-5 p. m., Music Box; readings, Courier-Journal, the Louisville Times; 7:30-9, I. & I. Terminal Railway orchestra; String Division of the K. & I. Terminal Railway orchestra.

WHB, Kansas City, Mo. (365.6), 2-3 p. m., Morrell Moore, organist; 7-8, John Burns, music.

WHO, Des Moines, Iowa (526), 6:30-7:30 p. m., Reese-Hughes orchestra; 7:30-9, Jim Blacksmith, harmonica soloist; Amelia Reinke, soprano; Marion Cowper, whistler; Cole and Kirkwood; Soudhalter and Jordan; 9-10:30, Corn Sugar orchestra; 10:30-12, dance program.

WHT, Deerfield, Ill. (399.8), 6-7:30 p. m., classical program; Pauline Sachs, soprano; Oscar Heather, tenor; Helen Ruth, pianist; Al Carney, organist; Grayling's string trio; (238), 7:45-9:15, musical features; (400), 9:30, request organ recital; Hickey and Johnson, harmony boys; Carl Strodel, baritone; Marie Wright, soprano; Leota Laabs, soprano; Al Carney, organist; 12, Pat Barnes, "Your Hour League"; Al Carney.

WJJD, Mooseheart, Ill. (302.8), 6-6:30 p. m., Howard Peterson, organist; 7-8, Belmont trio; 8-9, program, Mooseheart children; talk, M. P. Adams; 10-11, Alois Braggioni, Court Banks, Marie Winters, Romo Vincent; 12-1 a. m., announced.

WKRC, Cincinnati, Ohio (422.3), 8 p. m., book review, Alice Coy; 8:15, Marlon McKay and his orchestra; 8:45, popular studio features; 9:15, Marion McKay and his orchestra.

WLIB, Elgin, Ill. (302.8), 7-8 p. m., dinner concert, Drake concert ensemble; Blackstone string quintet; 9-10, Fred Hamer's orchestra; organ recital; 10-11, Jack Chapman's and the Blackstone hotel dance orchestras; jazz artists; 1-2 a. m., Chapman's orchestra; Blackstone hotel dance orchestra; jazz.

WLS, Chicago, Ill. (344.6), 6:30 p. m., Ralph Emerson, organist; 7:20, WLS studio trio; 8, poets' corner, Wallace Bruce Ansberry; 8:30, Ford and Glenn; 9:10, Charles Korvais, Mrs. Katherine Korvais, John Dosey; 10:10, quartet; 11-12, Ralph Emerson, organist.

WLW, Cincinnati, Ohio (422.3), 12:15 p. m., Irene Downing and Marjory Hebestreit; 4 p. m., "Shut In" concert; 7, Gibson hotel dinner music; 10, program, Association for the Welfare of the Blind; concert, sightless artists; address, Judge Samuel Bell; 10:45, Zither players; 10:55, "Experience in Police Court," Judge Merdith Yeatman; 11, Johanna Crosse and Carl Bamberger.

WMAQ, Chicago, Ill. (447.5), 12:45 p. m., Radio farm school; 1, Chicago Association of Commerce luncheon; 2, "Shut In" program; 4, Cosmopolitan School of Music; 4:30, Red Cross talk; 6, Chicago theater organ recital; 6:30, Georgene Faulkner, story lady; 8, lecture, Northwestern university; 8:30, Lillian Behberg, recital; Mrs. Jane P. Fritch, soprano; 9, WMAQ players.

WMBB, Chicago, Ill. (250), 7-8 p. m., Trianon duo;

Florence White Rush, Joel Lay; 9-11, Trianon orchestra; Woodlawn theater orchestra; Marquette banjo four, Billie Allen Hoff.

WOC, Davenport, Iowa (483.6), 4-4:45 p. m., M. Cohen, tenor; E. DeVogel, pianist; Frances Amiel, pianist; 5:45-6, chimes concert; 6:30-6:50, Sandman's bedtime stories; 9-10, Ipana troubadours, WFAF.

WOK, Chicago, Ill. (217.3), 12-2 p. m., Harold Morava, tenor; Jean Carlson, soprano; Banks Kennedy, organist; 6-7, Robert York, tenor; Eleanor Gilmore, soprano; Banks Kennedy, organist; LeRoy North, pianist; 10-11 a. m., Ned Miller, tenor; Herman Sinaiko, violinist; Harriet Lee, contralto; Rita McFawn, soprano; Cy Berg, ukulele soloist; Banks Kennedy, organist.

WORD, Batavia, Ill. (275), 8 p. m., Webster hotel concert trio; 8:15, hymns and sacred songs; I. B. S. A. choral singers; 8:30, address, Calvin H. Swingle.

WOS, Jefferson City Mo. (440.9), 8 p. m., musical program, Robert Warnick; Mrs. Lena Bell Newkirk, pianist.

WQJ, Chicago, Ill. (447.5), 3-4 p. m., "Planning a New England Dinner," Helen Downing; "Cheese Goodies," Martha Logan; "Living All Your Life," Dr. Cyrus J. Gaddis; 7-8, dinner concert, Ralph Williams; Everett George Ople, dramatic director and character reader, introducing first of a series of short stories, "The Most Dangerous Game;" 10-11 a. m., Ralph Williams and his Rainbo Skylarks; Lillian Schoessling, mezzo-soprano; Ellen Cook, soprano; Melodians; Esther Trostard, mezzo-soprano; Funtella trio; Tillie Miller; Fred A. Jacobson, melodist; Clarence Theaters, tenor; Sandy Meek, Scotch tenor; Harry Sosnick, pianist; J. Edwin Peterson, bass; artists.

WSAI, Cincinnati, Ohio (326), 3 p. m., address, Chief Justice Taft, dedication of Alphonse Taft College of Law; 8, "Lincoln the Emancipator," Waterman Pen program; 9, Ipana troubadours; 10, Congress playing card string quartet; Catherine Hoch, soprano.

WSB, Atlanta, Ga. (428.3), 10:45 p. m., Vick Meyers Melody orchestra.

WSMB, New Orleans, La. (319), 8:30-10:30 p. m., Mendelson's Radio band.

WSUI, Iowa City, Iowa (484), 12:30 p. m., phases of zoology, college of the air, Carpenter, Porter, Rucknick.



Charles Elliott, well-known saxophone artist and pianist, is the new artist at KTHS, Hot Springs National Park. Mr. Elliott studied both in the New England Conservatory of Music at Boston and the College of Music at Cincinnati.

Mountain Time Stations

KFWA, Ogden, Utah (261), 9-10 p. m., musical program, Globe Mills; 10-11, Lion Coal company, Ellis Fuel company; 11-12, Olie Reeves and his orchestra.

KOA, Denver, Colo. (322.4), 6:30 p. m., Herbert White and his Silver State orchestra; S. scientific football, Tam McNameara; 8:10, minstrel show, Stewart A. Housman, H. Gerald Sherman, Freeman H. Talbot; KOA orchestra.

Pacific Time Stations

KFOA, Seattle, Wash. (454.3), 6:45-8:15 p. m., Hopper Kelly company; 8:30-10, Times studio program.

KFPG, Hollywood, Calif. (238), 9 a. m., dad's hour, Dad King; 5-6 p. m., home hour with Georgia Simmons and neighborhood children; 8-9, KFPG concert orchestra; 9-10, KFPG concert hour, direction C. Harold Rainey.

KFWB, Hollywood, Calif. (252), 5-6 p. m., children's hour, Big Brother of KFWB; 6:30-7, program, E. P. James of Altadena, featuring Bill Hatch and Ray Kellogg; 7-7:30, Mutual Motors mirth contest; 7:30, microphone brevities; 8-10, program, John Wright, the Right Tailor, with Lee Kent and terapach; John Wright orchestra; Julian A. Marshall, tenor; Michel Howe, xylophone; 10-11, Warner brothers' frolic, direction Norman Manning.

KGO, Oakland, Calif. (361), 6-7 p. m., dinner concert, Baldwin Piano company.

KGW, Portland, Ore. (491.5), 12:30-1:30 p. m., Rose City trio; 7:15-8, book review, J. K. Gill company; 8-9, concert, Western Auto Supply company; 10-11, Sherman, Clay and company.

KHJ, Los Angeles, Calif. (405.2), 6-6:30 p. m., Leighton's Arcadia cantata orchestra, Jack Cronshaw, leader; 6:30-7:30, history story, Prof. Walter Sylvester Kentz; Dick Winslow, juvenile reporter, Mickey McBan and Baby Muriel MacCormac, screen juveniles; Uncle Remus; 8, Dr. Marc Baumgardt, scientific lecturer; 8:30-10:30, program, F. B. Miller Hudson-Essex company, arranged by J. Howard Johnson; 10:30-11:30, Art Hickman's Biltmore hotel dance orchestra, Frank Ellis, leader.

KJR, Seattle, Wash. (384.4), 7-8:30 p. m., Sears-Roebuck and company studio program; 8:30-10:30, Post-Intelligencer studio program.

KNX, Hollywood, Calif. (336.9), 5:30-6:15 p. m., Wurliizer pipe organ studio, Town Tattler; 6:15, travel talk, W. J. Alder; 6:30-7, Atwater Kent Radio orchestra; Paul Flinstein, leader; 7-8, Ambassador hotel concert orchestra, Josef Rosenfeld, leader; 8-9,



These two artists, the two funny men WAHG, Rich Hill, Arthur Hill, left, and Cliff Ullrich, right, make specialty of Je jokes. Cliff Ullrich a German comedian.

Wednesday, October 28

(Continued from page 11)

KMA, Shenandoah, Iowa (252), 6:45 p. m., domestic science, timely topics, Leona Teget, June B. Case; 9-11, Farmland trio.

KPRC, Houston, Tex. (296.9), 5:30 p. m., Uncle Judd's Kiddies' hour; 7:30, Margaret Moorhead, soprano; 8, Mary Catherine Evans, pianist; 8:30, J. F. Spencer, contralto; 9, Eddie Syncoators, Eddie Truberville, director; 11, Houston Light Opera company, Highinks.

KSD, St. Louis, Mo. (545.1), 7 p. m., Benjamin Rader's orchestra.

KTHS, Hot Springs National Park, Ark. (374.8), 9-9:20 p. m., violin recital, Lon Chassy, John G. Heyn, pianist; 9:20-9:50, organ recital, Luis Cohn; 9:50-10, Meyer-Davis ensemble; 10-10:10, Mrs. Byrd Riggsby, contralto; 10:10-10:45, dance tunes, Southerners Majestic hotel orchestra.

YW, Chicago, Ill. (535.4), 11:35 a. m., table talk, Mrs. Ann J. Peterson; 3:35-7, children's bedtime story; 7-7:30, dinner concert, Congress hotel; 8-9, Kathryn Callaghan, soprano; Mrs. A. Ranney Johnson, reader; Mrs. Kenneth Stewart, humorist; Cecilie Bryerton, violinist; Bertha Wolfarth, pianist; 10-12:30, midnight revue.

WAND, Minneapolis, Minn. (243.8), 7 p. m., Garrick theater symphony orchestra; 7:30, Garrick theater organ, Jack Macbrich; 8, Elsa Olson Super, accordionist; George Super, violinist; C. Clemons, tenor; A. E. Swan, accompanist; 10:30, Skyrocket frolic.

WBAP, Fort Worth, Tex. (475.9), 7:30-8:30 p. m., Panther Hawaiian trio; 9:30-10:45, Fred Cahoon's Texas hotel orchestra.

WBBM, Chicago, Ill. (226), 5:30-6 p. m., Kiddies' Joy-Digger club; 8-10, Frances Ingram, operatic contralto; Sunset quartet; Clarence Deger, tenor; Doris Ryan, pianist; Bernard Gamson, violinist; Hazel McBroom, contralto; 12-2 a. m., Harold Anderson, accordionist; Lew Russell, Charlie Garland, Leda Caldwell, Eddie Loftus, Torrid two; Montmarie orchestra.

WCCO, Minneapolis-St. Paul, Minn. (416.4), 7 p. m., Park Avenue Congregational church; 8, WFAF, Points of Progress, Ipana Troubadours; 10:05, Wallie Erickson's Coliseum orchestra; 11:30, Eddie Dunstedter, organist.

WDAF, Kansas City, Mo. (365.6), 3:30-4:30 p. m., Star's string trio; 6-7, address: Tell-Me-a-Story Lady; Trianon ensemble; 8-9:15, Star's Radio string orchestra; 11:45-1 a. m., Morry Old Chief, Plantation players; Ted Meyn, organist.

WEBB, Chicago, Ill. (370.2), 7-8 p. m., Oriole orchestra; Florence Behrend, soprano; 9-10, Oriole orchestra; Correll and Gosden; Robert York, tenor; 11-1, Oriole orchestra; Correll and Gosden; Robert York, tenor; Oriole orchestra.

WENR, Chicago, Ill. (266), 6-7 p. m., dinner concert, Rauland lyric trio; violinist, soprano; 8-10, popular program, All-American pianists; J. E. Peterson, bass; John Papa, concertist; Archie Rawls, tenor; Floyd Falch, Vincent Vallee, tenor.

KNX feature program; 9-10, program with a kick, Hercules Gasoline company; Elmer, Mandy and the Mule; 10-11, hour of dance music.

KPO, San Francisco, Calif. (428.3), 2:30-3:30 p. m., Rudy Seiser's Fairmont orchestra; Duke Kamoku's Royal Hawaiians; 3:30, talk on fashions; 6:40-7, Waldemar Lind and the States Restaurant orchestra; 8-9, Atwater Kent artists; 9-9:30, Goodrich Silvertown Cord orchestra; 10-11, Waldemar Lind and the States Restaurant orchestra.

KWSC, Pullman, Wash. (348.6), 7:30-9 p. m., Rosalia Koeh, pianist; Olga Kraus, violinist; piano, vocal and banjo selections, Eric Danielson, Ingwald Henneberg; "Curing Hams and Bacon on the Farm," R. T. Smith; "Advantages of Winter Egg Production," W. D. Buchanan; "See Your Architect Now," S. A. Smith; book reviews, Alice Webb.

Thursday, October 29

Headliners Today

Eastern 8:30 **Central** 7:30 **Mountain** 6:30 **Pacific** 5:30
KDKA (309.1)—Sleepy Hollow trio.
WHO (526)—Raleigh quintet.

9 8 7 6
WCBD (344.6)—Zion band.
10 9 8 7

WCAU (278)—Sesqui Centennial hour.
WKRC (422.3)—Old English songs.
WMCA (340.7)—Manhattan Serenaders.
10:30 9:30 8:30 7:30

WBAP (475.9)—Music conservatory program.
WGR (319)—LeParadis Roof band.
11 10 9 8

KGO (361)—Witching hour, 4-act drama.
KYW (535.4)—Evening at home.
11:30 10:30 9:30 8:30

KTHS (374.8)—Dance tunes, Meyer-Davis orchestra.
WGY (379.5)—Organ recital.
1 12 11 10

KFWB (252)—Famous Movieland orchestra.
KPO, Waj.

Thursday, silent night for: CHIC, CKNC, CNRA, CNRE, CNRO, CNRR, CNRT, CNRV, KFAB, KFAU, KFDM, KFMO, KFMR, KFOA, KFRU, KFUO, KFVE, KFWA, KGW, KOA, KOB, KSD, KTCL, KWSC, PWAZ, WAHG, WCEE, WEAD, WEBJ, WGCP, WHAD, WHAZ, WJJD, WLIT, WLWL, WOR, WOS, WSUI, WTAM.

Eastern Time Stations

CFCA, Toronto, Can. (356), 6:30 p. m., results Canadian general elections.

KDKA, Pittsburgh, Pa. (309.1), 8:15 p. m., KDKA Little symphony orchestra; 7:30, a minstrel show, Uncle Ed; 8, "What Is Radio?"; 7:45, "Italy Revisited," N. A. N. Cloven; 7:45, U. of Pittsburgh; 8:30, "Wolfgang Amadeus Mozart," Richard Kountz; KDKA Little symphony orchestra; Sleepy Hollow trio; 9, KDKA Little symphony orchestra; 11, midnight concert, WAHG, Richmond Hill, N. Y. (315.6), 12-12:30 p. m., musical program.

WBBR, New York, N. Y. (272.6), 8 p. m., instrumental

'ES PROGRAM WEDNESDAY FROM WRC

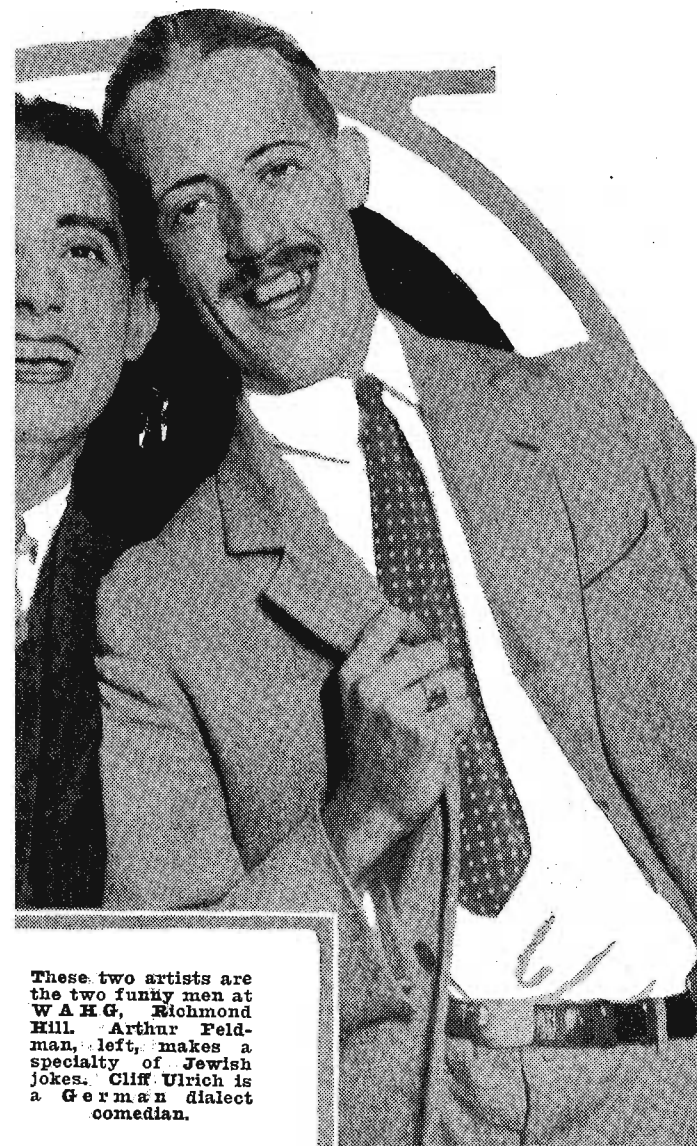

These two artists are the two funny men at WAHG, Richmond Hill. Arthur Feldman, left, makes a specialty of Jewish jokes. Cliff Ulrich is a German dialect comedian.

chestra; 2:30, Dorothy Bang, contralto; Leah Trabin, pianist; 7:30, Dream Daddy's bedtime stories.

WMCA, New York, N. Y. (340.7), 6-7 p. m., Oleott Wall and his Hotel McAlpin string ensemble; 7-7:30, Sunnyside orchestra; 7:30-8, Lamson's orchestra; 8-8:30, democratic campaign talk; 8:30-9:15, Snelton Weir, baritone; 9:15-9:30, Minnie Weir, pianist; 10-11, Manhattan serenaders; 11-12, Ernie Golden and his Hotel McAlpin orchestra.

WOR, Newark, N. J. (405.2), 3:45-4 p. m., talk, E. P. Adams; 6:15-7:15, Hotel Shelton orchestra; 7:15-7:30, sports talk.

WRC, Washington, D. C. (469), 10 a. m., woman's hour; 12 m., organ recital; 1 p. m., Hotel Washington orchestra; 7, Lee House trio; 8, Smithsonian talk; 8:15, U. S. Army band; 9:15, to be announced; 9:30, Royal Salon orchestra; 10:30, Meyer Davis' Le Paradis roof band.

WREO, Lansing, Mich. (285.5), 6-7 p. m., dinner concert; 8:15, Reo Broadcasting orchestra; Reo male quartet; Reo string quartet.

WTAG, Worcester, Mass. (268), 8 p. m., Larkinites; 8:30, pop concert; 9-10, program; 10, Silvertown Cord orchestra.

WTAM, Cleveland, Ohio (389.4), 12-1 p. m., lunch hour music; 6-7, Hotel Hollenden orchestra.

WTIC, Hartford, Conn. (475.9), 6:30 p. m., Hub Restaurant trio; 7:30, "The Policeman Goes to School Too," Lt. Edward J. Langrist; 9, minstrel show.

WWJ, Detroit, Mich. (352.7), 12:05 p. m., Jules Klein's Hotel Statler orchestra; 3, Detroit News orchestra; 6, dinner concert; 8, concert from WEA.

Central Time Stations

KFNF, Shenandoah, Iowa (266), 7 p. m., concert, Indian Mission, Elder Creel, director.

KLDS, Independence, Mo. (441), 8 p. m., Kansas City Central church choir; Eugene Christy, director; Elizabeth Hitchcock, organist; C. C. C. quartet; M. A. Etzenhauser, beginning winter lecture course series.

KMA, Shenandoah, Iowa (252), 6-7 p. m., flower talk, Lina Ferguson; 9-11, Delmonico Dreamers.

KPRC, Houston, Tex. (296.9), 5:30 p. m., Uncle Judd's Kiddies' hour; 7:30, Blanchard's dance orchestra, Clude Blanchard, leader; 8:30, C. C. Sowerby, basso; George A. Delhomme, dramatic soprano; Mrs. F. Anderson, accompanist; Herbert A. Heltmann, violinist; 9, Field Reynaud, popular pianist.



Nina Gene Shelby is one of the attractive entertainers at KWKH, Shreveport. She has a pleasing contralto voice and plans to study at the Conservatory of Music in Cincinnati.

KTHS, Hot Springs National Park, Ark. (374.8), 9-9:45 p. m., fiddle concert, Waterloo fiddle band; 9:45-10:15, Central Methodist church choir, soloists; Arthur Platz, director; 10:15-11, dance tunes, Meyer-Davis orchestra; Lon Chassy, director.

KYW, Chicago, Ill. (535.4), 11:35 a. m., table talk, Mrs. Anna J. Peterson; 6:35-7, children's bedtime story, Uncle Bob; 7-7:30, dinner concert, Congress hotel; 7:33-7:53, "Training Boys for Live Stock Farming," J. E. Hill; 8-8:20, "Twenty Minutes of Good Reading," Rev. C. J. Perrin; 8:20-9:20, musical program; 9:20, "What to Do with Spareribs," John C. Cutting; 10-11:30, evening at home.

WAMD, Minneapolis, Minn. (243.8), 6 p. m., dinner concert, George Osborn's orchestra; 7:05, Gaby's the Limit Army; Warren M. Tingdahl; 10:30, Skyrocket Trio, George Osborn and his Skyrocket orchestra.

WBAP, Fort Worth, Texas (475.9), 7:30-8:30 p. m., music, Dr. Richard Mandell, director; 9:30-10:45, Fort Worth Conservatory of Music, B. U. Taylor, director.

WBBM, Chicago, Ill. (226), 5:30-6 p. m., Kiddies' Joy-Digger club; 8-9, Samovar orchestra; Nate Caldwell, Jim Gleason, Charlie Garland, Eddie Loftus; 9-10, Montmarie orchestra; Marie Morout, harpist; Joseph Raloff, pianist; Devon comedy four; 10-12, Paul Small; Doris Ryan, pianist; Bert Davis; Four Cousins quartet; Fair and Warner duo, artists; string quartet.

WCBD, Zion, Ill. (344.6), 8 p. m., Zion band; Wiedman sisters, double duet; vocal solos; M. P. Barton, tenor; John Thomas, baritone; P. M. LaRose, contralto; Bessie Schaefer, pianist; Wesley Carey, reader.

WCCO, Minneapolis-St. Paul, Minn. (416.4), 7 p. m., program WBAF, Larkinites, pop concert; Silvertown cord orchestra; 10:05, travel talk, National Directors Travel bureaus.

WDAF, Kansas City, Mo. (365.6), 6-7 p. m., book talk, Louis Mecker; Tell-Me-a-Story Lady; Trianon ensemble; 11:45-1 a. m., Merry Old Chief; Carl Nordberg's Plantation players; Charles Donberger's Kansas City Athletic Club orchestra; Earl Coleman's Ambassador hotel orchestra.

WENT, Chicago, Ill. (266), 6-7 p. m., dinner concert; Rauland lyric trio; violin and cello selections, Frank Westphal; 8-10, popular program; Ray Hibbeler; Rose Kutta, soprano; Will Rostler, Burt Davis, Vic Fredericks; Strand Harmony four.

WEBH, Chicago, Ill. (370.2), 7-8 p. m., Oriole orchestra; recital; 9-10, Oriole orchestra; Katherine Forbes, soprano; Beulah Ladon, violinist; 11-1 a. m., Oriole orchestra; stories, Wayne Myers; Paul Small.

WFAA, Dallas, Texas (475.9), 12:30-1 p. m., address, DeWitt McMurray; 6:30-7:30, Lono Star Five orchestra; 2:30, Dorothy Bang, contralto; Leah Trabin, pianist; 7:30, Dream Daddy's bedtime stories.

Index to Classical Concerts

Tabulated below is a time table of the stations giving classical concerts this week. Stations are divided into the four different standard times in use. The hours are given in the kind of time in use at each listed station. By using this table as an index and referring to the complete programs below, full information will be obtained.

Classical

Eastern Time Stations

Saturday, October 24: 6, WCX, WEA, WMCA, WREO; 6:17, WOR; 6:30, WCAE; 7, WEAR, WNYC, WRC; 7:15, WEA; 7:35, WEA; 8, WBBR, WNYC; 8:15, WRC; 8:30, WCAE; 8:40, WBBR; 9:30, WEA; 10, WEA.

Sunday, October 25: 6, WCAU; 6:30, WCAE, WOR; 7, WEAR; 7:20, WCAE, WCTS, WEA, WEEL, WWJ; 8, WBZ, WEAR, WGBS, WGCP, WKAQ; 8:30, KDKA, WBZ, WGCP; 9, WBZ, WEAR, WGY, WHAR, WNYC; 9:15, WCAE, WCTS, WEA, WEEL; 9:20, WNYC; 9:45, WCTS, WGCP; 10, WNYC; 11, WHN; 11:15, WHAR.

Monday, October 26: 6, WCX, WEA, WMCA, WREO, WWJ; 6:05, WIP; 6:30, CFCA, WBZ, WCAE, WGY, WTIC; 7, WEA, WEAR, WJR, WOO; 7:15, WEA; 7:30, WEEL, WGY, WMCA; 8, WBBR, WBZ, WCAU, WCX, WHAR, WTIC; 8:15, WBZ, WHAZ, WNYC; 8:30, CHNC, KDKA, WBBR, WBZ, WGCP; 8:45, WEA, WOO; 8:55, WBBR; 9, WBZ, WCAE, WEEL; 9:10, WLIT; 9:15, WGCP; 9:30, WBZ; 10, CHNC, WEA, WOO; 10:10, WEEL; 10:15, WOO; 10:30, KDKA; 10:40, WEEL; 11, WHN.

Tuesday, October 27: 6, WBZ, WCX, WEA, WMCA, WREO, WWJ; 6:05, WIP; 6:17, WOR; 6:30, WCAE, WGY, WTIC; 7, WEAR, WEEL, WGBS, WJR, WOR, WTIC, WWJ; 7:20, WTIC; 7:30, WCAU, WEA, WOO; 7:45, WEEL; 8, WBZ, WCAE, WCAU, WCX, WEAR, WEEL, WGR, WHAR, WRC, WTIC; 8:05, WNYC; 8:15, WEEL; 8:30, KDKA, WBZ, WCAE, WCTS, WEA, WEEL, WFI, WGR; 9, WCAE, WCTS, WEA, WEEL, WFI, WGR; 9:15, WREO; 9:30, WBZ, WHN, WRC, WTIC; 10, WCAE, WCTS, WEA, WEAR, WEEL, WFI, WMCA; 10:30, WGR; 11:15, WHAR.

Wednesday, October 28: 6, WCX, WEA, WMCA, WREO, WWJ; 6:05, WIP; 6:30, WBZ, WCAE, WTIC; 6:45, WGY; 7, WEAR, WJR; 7:20, WTIC; 7:30, WEA, WEEL, WOO; 8, WBZ, WCTS, WCX, WEA, WEEL, WKAQ, WMCA, WWJ; 8:05, WNYC; 8:15, WCAU, WOR; 8:30, KDKA, WBZ, WCAE, WEA, WOO, WOR; 8:45, WBZ, WCAU, WEEL; 9, WBZ, WEEL, WGR, WOR; 9:15, WBZ, WCAU; 9:30, WNYC; 9:45, WOR; 10, WEA, WEEL, WGR, WNYC, WOO; 11, WCAE.

Thursday, October 29: 6, WBZ, WCX, WEA, WMCA, WREO, WWJ; 6:05, WIP; 6:17, WOR; 6:30, WCAE, WGBS, WGY, WOR, WTIC; 7, WEA, WEAR, WGBS, WJR, WWJ; 7:30, WCAU, WEEL, WHN, WOO, WRC; 7:45, WGY, WTIC; 8, WBBR, WBZ, WCAU, WCX, WEAR, WEEL, WGR, WGY, WHAR, WIP, WTIC; 8:15, WNYC; 8:30, KDKA, WBZ, WCTS, WEEL, WHN, WMCA, WREO; 8:40, WBBR; 8:45, WBZ; 9, WCAE, WCAU, WEA, WEEL, WFI, WGR, WHAR, WNYC, WRC; 9:30, WREO; 10, WCAE, WCAU, WCTS, WEA, WEAR, WEEL, WGR, WGY; 10:15, KDKA; 11:30, WGY.

Friday, October 30: 6, WCX, WMCA, WREO, WWJ; 6:05, WIP; 6:30, CNRT, WBZ, WCAE; 7, WEBJ, WGY, WJR, WOR, WTIC; 7:30, WEEL, WOO, WTIC; 7:45, WEEL; 8, WAHG, WBZ, WCAU, WCTS, WCX, WEEL, WEEL, WTIC, WWJ; 8:05, WNYC; 8:10, WHAR; 8:30, KDKA, WCAE, WEEL, WOO; 8:45, WAHG, WBZ; 9, CNRT, WBZ, WCAU, WEEL, WMCA, WOO; 9:30, WEEL; 10, WEEL, WNYC, WOO; 10:30, WGR, WGY; 11:15, WHAR.

Central Time Stations

Saturday, October 24: 6, KFAB, WENR, WMAQ, WOAW, WOK; 6:15, WCCO; 6:30, WGN; 7, KOIL, KSD, KYW, WGN, WMBB, WQJ; 7:30, WEBH, WHAS; 8, KFNF, KPRC, KYW; 8:15, WCCO; 8:30, KYW, KPRC, WFAA, WHAS, WMC; 9, WKRC, WMAQ, WOAW, WOC; 9:15, KPRC; 9:30, WOC.

Sunday, October 25: 6:30, KLDS, WHT; 6:45, WORD; 7, KYW, WLS, WORD; 7:30, WHO; 8, KFDM, KPRC, WCBD, WFAA, WGN, WQJ; 8:30, WLW; 9, WQJ; 9:10, KTHS; 9:15,

KLDS, WCCO, WHT; 9:25, KTHS; 9:30, WFAA, WOC; 10, KFVE, KTHS, WOC; 10:30, WHT; 11, WOC.

Monday, October 26: 6, KFAB, KMA, WHAD, WOAW, WOK; 6:30, WGN; 6:45, WOAW; 7, KFNF, WHT, WLW, WMBB; 7:30, KOIL, KPRC, WBAP, WHO; 8, KPRC, WHAD, WHO, WLW, WORD, WOS; 8:30, KPRC, WBAP, WFAA, WMC, WOAI; 9, KFAX, KMA, KPRC, KSD, KTHS, WHAD, WOAW; 9:30, KTHS; 9:45, KTHS; 10, KFAX, KMA, KTHS, WSAI; 11, WBAP, WSAI.

Tuesday, October 27: 6, KFAB, KMA, WHAD, WMAQ, WOK; 6:05, WCCO; 6:30, WFAA, WGN, WLW; 6:45, KSD; 7, KFNF, KYW, WHT, WLS, WMBB, WQJ; 7:30, KOIL, WCCO, WHAS, WHO, WOC; 7:45, WSAI; 8, KFDM, KLDS, KYW, WCBD, WCCO, WLW, WMAQ, WOC, WORD; 8:30, KPRC, WGN, WLW, WMC, WOAI, WORD; 8:45, KYW; 8:50, WMAQ; 9, KFDM, KFMA, KPRC, KTHS, WCCO, WHAS, WLW, WOC, WSAI; 9:25, KTHS; 9:30, WBAP; 10, KMC, KYW, WSAI; 11, WHO.

Wednesday, October 28: 6, KMA, WHAD, WMAQ, WOK; 6:15, WLS; 6:30, KOIL, WGN, WHO; 7, KFNF, KPRC, KYW, WHT, WLW, WMBB, WQJ; 7:30, WHAD; 8, KPRC, KYW, WCCO, WDAF, WHAD, WMAQ, WOC, WORD; 8:30, KSD; 8:15, KOIL, WORD; 8:30, PWX, KPRC, WGN, WOAI; 9, KMA, WCCO, WHAD, WLS, WMAQ, WOC; 9, KTHS; 9:25, KTHS; 9:30, PWX; 9:45, KTHS; 10, KMA, KTHS, WLS, WLW, WOC, WSAI; 10:10, WSAI; 10:30, WLW; 11, WHAD, WLW; 11:30, WCCO, WLW; 11:45, WLW.

Thursday, October 29: 6, KMA, WHAD, WMAQ, WOAW, WOK; 6:30, WGN; 7, KYW, WHT, WLS, WLW, WMBB, WOAW, WQJ; 7:30, KFNF, KOIL, WHAD, WHO, WSAI; 8, KLDS, WBAP, WCBD, WCCO, WOC, WORD, WSAI, WSB; 8:20, KYW, WMAQ; 8:30, KPRC, WFAA, WGN, WHAD, WMC, WOAI; 8:35, WMAQ; 9, KPRC, KTHS, KYW, WCCO, WHAD, WOAW, WOC, WSAI; 9:10, KTHS; 9:30, KFAB, KTHS, WBAP; 9:45, KTHS; 10, WSAI; 10:30, WLW; 11:45, WLW.

Friday, October 30: 6, WHAD, WMAQ, WOAW, WOK; 6:15, WCCO; 6:30, WGN; 6:50, WMAQ; 7, KYW, WHT, WLS, WQJ; 7:30, KFNF, KOIL, KSD, KYW, WBAP, WHAD, WHO; 8, KFDM, WCCO, WDAF, WHAD, WMAQ, WSAI; 8:30, KFAB, WFAA, WGN, WHAD, WHO, WMAQ, WMC, WORD; 9, KFDM, KFAX, WHAD, WMAQ; 9:05, WCCO; 9:10, KTHS; 9:30, KFAB, KTHS, WBAP; 9:45, KTHS; 10, KFAX.

Mountain Time Stations

Monday, October 26: 6:30, KOA; 8:10, KOA.

Tuesday, October 27: 6:30, KOA; 7:30, KOA.

Wednesday, October 28: 6:30, KOA; 8:10, KOA.

Thursday, October 29: 6:30, KOA; 9, CNRC.

Friday, October 30: 6:30, KOA; 8:10, KOA; 8:30-10:30, CNRE.

Pacific Time Stations

Saturday, October 24: 6, KFOA, KHJ; 6:30, KNX; 6:45, KFOA; 7, KNX; 7:30, KNX; 8:10, KGO; 8:15, KHJ.

Sunday, October 25: 6:30, KHJ; 6:35, KPO; 7, KHJ, KNX; 8, KHJ, KNX, KPO; 9, KHJ, KNX; 10, KNX.

Monday, October 26: 6, KFOA, KGO; 6:30, KNX; 6:45, KFOA; 7, KPO; 7:30, KNX; 8, KGW, KHJ; 9, KGW; 10, KHJ.

Tuesday, October 27: 6, KFOA, KGO, KHJ; 6:30, KNX; 6:45, KFOA; 7, KNX; 8, KGO, KHJ; 8:30, KFOA; 9, KGW, KPO.

Wednesday, October 28: 6, KFOA, 8:30, KNX; 7, KNX; 8, KGO, KGW, KPO; 9, KGW, KPO.

Thursday, October 29: 6, KHJ; 6:30, KNX; 7, KNX; 8, KGO, KPO; 9, KGW, KPO.

Friday, October 30: 6, KFOA, KGO, KHJ; 6:15, KPO; 6:45, KFOA; 7:30, KFAX, KNX; 8, KHJ, KNX, KPO; 8:30, KFAB; 9, KPO.

(Continued on page 14)

Thursday, October 29

(Continued from page 13)

8:30-9:30, farmers' hour, Rea A. Nummallee; 11-12, J. J. Sanders, pianist. WGN, Chicago, Ill. (370.2), 12:40 p. m., Drake concert ensemble. Blackstone string quintet; 2:30, artist series. Lyon and Healy; 3:30-4:15, tea time music, Marshall Fields tea room orchestra; 6:30, Drake concert ensemble. Blackstone string quintet; 8-9, WGN string trio; 10-11, Jack Chapman's orchestra; Blackstone hotel dance orchestra. WHAD, Milwaukee, Wis. (278), 6-7 p. m., Bill Benjamin's Milwaukee Athletic club orchestra. WHAS, Louisville, Ky. (399.8), 4-5 p. m., Music Box; 7:30-7:50, Royal Pencook orchestra; 7:30-9, Choir quartet, First Presbyterian church. WBB, Kansas City, Mo. (365.6), 2-3 p. m., Sweeney string trio; 7-7:30, Morrell Moore, organist; 8-9, artists recital, Amy Wanning; 9-10, Ceaty's School of dancing. WHO, Des Moines, Iowa (526), 7:30-8 p. m., Raleigh quintet; 8-9, Bankers Life trio; 11-12, Bankers Life Little symphonic orchestra. WHT, Des Moines, Ill. (399.8), 6-7:30 p. m., classical program; Grayling's string trio; Wilkens and Martens, Melody Mads; John Clark, baritone; Bernice Taylor, soprano; Helen Rauh, pianist; Al Carney, organist; (238), 7:45-9:15, musical features; (400), 9:30, Jelle entertainers; U. S. L. half hour of dance music; Kenneth Clark's Hawaiian trio; Howard Sherston, tenor; Al Carney, organist; Husk O'Hare's orchestra; 12, Pat Barnes, "Four Hoop League"; Al Carney. WKRC, Cincinnati, Ohio (422.3), 8 p. m., Percy Affinowsky, violinist; Al Kirschner, pianist; Pep Golden, saxophonist; features. WLFB, Elgin, Ill. (302.8), 7-8 p. m., dinner concert. Drake concert ensemble; Blackstone string quintet; 9-10, Fred Hamm's orchestra; organ recital; 10-11 Jack Chapman's and the Blackstone hotel dance orchestras; jazz artists; 1-2 a. m., Chapman's orchestra; Blackstone hotel dance orchestra, jazz. WLS, Chicago, Ill. (344.6), 6:30 p. m., Ralph Emerson, organist; 7-20, Prof. Nahat's program. WLW, Cincinnati, Ohio (422.3), 12:15 p. m., Mildred Prigge, organist; 4, piano recital, Adelaide Apfel; 7, dinner concert, Hotel Gibson orchestra; 10, Doherty Melody Boys; 10:30, Warren Foster, boy soprano; 10:45, Homer Scott, tenor; 10:55, Crosby-Salon orchestra; organ solos, Elmer Dimmerman on WLW organ; 12:15, "Crosby Sky Terriers." WMAQ, Chicago, Ill. (447.5), 12:45 p. m., Radio Farm school; 2, shift-in program; 4, Illinois Federation of Women's clubs; 6, Chicago theater organ recital; 6:30, Hotel LaSalle orchestra; 8, garden talk, James H. Burdett; 8:15, boy scouts; 8:30, Association of Commerce talk; 8:40, to be announced; 9, University of Chicago lecture; 9:20, Helen Pollenz, pianist. WMBB, Chicago, Ill. (250), 7-8 p. m., Trio duo; Beatrice Teller, Jean Ballard, Babi & Barr, Mildred Matelka, Clarence Jacobs, Paul Cadieux; 9-11, Trio duo orchestra; Woodlawn theater orchestra; Billie Allen Hoar. WDAW, Omaha, Neb. (526), 12:45 p. m., Randall's Royal Fontenelle orchestra; 6, classical; 7, Randall's Royal Fontenelle orchestra; 9, orchestra. WOC, Davenport, Ia. (483.6), 5:45-6 p. m., chimes concert; 6:30-6:50, Sandman; 7-7:30, WEAF Larklines; 7:30-9, musical program, WEAF; 9-10, WEAF Silver-toned band orchestra; 11-12, LeClair hotel orchestra; Peter MacArthur, baritone. WOK, Chicago, Ill. (217.3), 12-2 p. m., August Breidermeir, tenor; Ethel Price, soprano; Banks Kennedy, organist; LeRoy North, pianist; 6-7, Helen Smith, soprano; William Balbach, tenor; Banks Kennedy, organist; LeRoy North, pianist; 10-11, Sandy Meek, tenor; Harry Sosnik, pianist; Herman Shuiko, violinist; Harriet Lee, contralto; Bill Bourke, Sonny Brown; Banks Kennedy, organist; Bill May, bass. WORD, Batavia, Ill. (278), 8 p. m., Webster hotel concert trio; 8:15, Sunday school lesson; 8:30, Chicago musical college; 9:15, Bible questions and answers. WQJ, Chicago, Ill. (447.5), 7-8 p. m., "New Pastry Wrinkles," Helen Downing; 3-4, dinner concert, Ralph Williams and his Rainbo Gardens orchestra; Kenneth Sterling, baritone; Maude Cousa, lyric soprano; Lavine Price, pianist; 10-11 a. m., Ralph Williams and his Skyarks; Jerry Sullivan; Rosa Vanderloesch, soprano and pianist; Bert Davis, Gene Lee, Ralph Keim, pianologist; Anne Klein, mezzo-soprano; Marie Wright, soprano; Lew Butler, Alma Adair and artists; 1-2, Ginger hour. WSB, Atlanta, Ga. (428.3), 8 p. m., Dr. Charles A. Sheldon, organist; 10:45, Howard theater backstage bunch. WSMB, New Orleans, La. (319), 8:30-10:30 p. m., Broadway serenaders, Liberty theater orchestra. WSUI, Iowa City, Iowa (484), 12:30 p. m., popular physics; Mrs. Preston C. Coast, organist.

Mountain Time Stations

CNRC, Calgary, Can. (455.8), 9 p. m., old time music, C. N. Railways' instrumental quartet. KOA, Denver, Colo. (322.4), 12:15 p. m., Rialto theater musicals; 3:30, musical features; 4, fashion; 6:30, Herbert White and his Silver State orchestra.

Pacific Time Stations

KFPG, Hollywood, Calif. (238), 9 a. m., dad's hour, Dad King; 5-6 p. m., home hour with Georgia Simmons and pupils Carter Weaver in continuity program; 8-9, KFPG orchestra, Margaret McNeal, soprano; 9-10, KFPG dance orchestra. KFVB, Hollywood, Calif. (252), 7:30 p. m., microphone brevities; 7:50, Jack Boaz, fishing scout; 8-9, program, Starr Piano company, Hollywood Rhythm Kings and Ina Mitchell Butler, soprano, in arrangements Gennett records; 9-10, program, Don P. Smith, Inc., Diana-Moon orchestra; Max Ibber, banjo; Sol Hoopii's piano-Hawaiian trio; 10-11, Warner brothers' frolic, direction Norman Manning with Harry G. Keiper's Famous Movieband orchestra. KGO, Oakland, Calif. (361), 8 p. m., "The Witches Hour," KGO players; 10-12 Ben Black's orchestra. KGW, Portland, Ore. (491.5), 12:30-1:30 p. m., Rose City, J. Los Angeles, Calif. (405.2), 6-6:30 p. m., Leighton's Arcade cafeteria orchestra, Jack Cronshaw, leader; 6:30-7:30, history story, Prof. Herzog; Dickie Brandon, screen juvenile; Udey Remus, guest announcer; 7:45, "Care of Body," Dr. Phillip M. Lovell; 8-10, program, Young's Market company, arranged by Neva Childberg; 10-11, Art Hickman's Billmore hotel dance orchestra, Frank Ellis, leader. KJR, Seattle, Wash. (384.4), 1:15 p. m., organ recital; 2, home helps, Bernice Redington; 8:30, Puget Sound Savings and Loan association concert orchestra; 10:30, Keep Joy Radiating Order of Bats. KNX, Hollywood, Calif. (336.9), 5:30-6:15 p. m., Wuritzer pipe organ studio, Town Butler; 6:15, travel talk, W. E. Alder; 6:30-7, Aviator Kent Radio orchestra, Paul Finstein, leader; 7-8, KNX feature program; 8-9, program, Globe Ice Cream company; 9-10, program, Weber Baking company; 10-11, Ray West's Coconut Grove dance orchestra from Ambassador hotel. KPO, San Francisco, Calif. (428.3), 1-2 p. m., Rudy Seiger's Fairmont hotel orchestra; 2:30-3:30, matinee program; 3:30-4:30, Palace hotel concert orchestra; 6:40-7, Waldemar Lind and the States Restaurant orchestra; 7-7:30, Rudy Seiger's Fairmont hotel orchestra; 8-9, program, Don Lee Cadillac company; 9-10, program, Young Ladies' Institute, Young Men's institute; 10-11, Jack Coakley's Cabriars.

Friday, October 30

Headliners Today

Eastern 7:30 WFAA (475.9)—Hawaiian music recital. 7:40 WGY (379.5)—"His Family," comedy-drama. Central 6:30 WFAA (475.9)—Hawaiian music recital. 6:40 WGY (379.5)—"His Family," comedy-drama. Mountain 5:30 WFAA (475.9)—Hawaiian music recital. 5:40 WGY (379.5)—"His Family," comedy-drama. Pacific 4:30 WFAA (475.9)—Hawaiian music recital. 4:40 WGY (379.5)—"His Family," comedy-drama.

Table with 4 columns: Eastern, Central, Mountain, Pacific. Shows station call letters and times for Thursday, October 29.

Friday, silent night for: CHIC, CKNC, CNRC, CNRM, CNRO, CNRR, CNRT, CNRW, CFMO, KFRU, KFUO, KGO, KLDK, KOB, KPRC, KUOM, WBBR, WCB, WEO, WFI, WGBS, WHAZ, WIP, WKRC, WLW, WRD, WRC, WRBS, WSAI, WSMB, WSUI, WTAM.

Eastern Time Stations

CNRA, Moncton, Can. (291), 8 p. m., artists from Sussex, N. B., George S. Piers, S. W. Wallace, directors; CNR dance orchestra. CNRM, Montreal, Can. (411), 8:30 p. m., Hart House string quartet. KDKA, Pittsburgh, Pa. (309.1), 6:15 p. m., dinner concert; 7:45, "Problems Connected with the Health of a City," C. J. Vaux; 8:30, Dutch Master half hour; 9, Teaberry time. WAHG, Richmond Hill, N. Y. (315.6), 12-12:30 p. m., musical program; 3-3:15, musical program. WBZ, Springfield, Mass. (333.1), 6:30 p. m., Leo Reisman's Hotel Lenox ensemble; 7:05, Civil Service examination information; 8, Frank Carl, pianist; 8:15, Ethel Michalek, dramatic soprano; 8:30, concert, Mrs. A. Thomson, contralto; Mrs. Weston Donovan, soprano; Alexander Thomson, pianist; 9, "Whatdoyoucallit" club; 10:05, McNeilly's singing orchestra. WCAU, Philadelphia, Pa. (277.6), 8 p. m., Houston club weekly student smoker; 8:45, "Talk on Chiropractic," Dr. Douglas G. M. Hill's Harmony four; 9:30, "Billy the Shoemaker Man"; 9:45, Rennie Cornack, popular song writer; 10:30, Loesser's dancing academy orchestra. WCX, Detroit, Mich. (517), 6 p. m., dinner concert, Book-Cadillac hotel; 10, Blue Room dance orchestra. WFAF, New York, N. Y. (491.5), 4-4:15 p. m., Mildred Praze, soprano; 4:15-4:30, Alice Soderman, reader; 4:30-4:45, Steven D'Isray, pianist; 4:45-5, talk; 6-7, dinner music, Waldorf-Astoria; 7-7:15, Ernest Wendell Nickel, whistler; 7:15-7:30, Carl Rosler and Dorothy Roeder, pianists; 7:30-7:45, "Sir Holgoblin's Magic Candle," Blanche Elizabeth Wade; 7:45-8, Carl and Dorothy Roeder; 8-8:30, Happiness Candy Boys; 8:30-9, Bagle Nedyroine trio; 9-9:15, Crescent male quartet; 9:15-9:30, May Breen, banjoist; Peter DeRose, pianist; 9:30-9:40, talk, Lawrence S. Mayer; 9:40-9:50, Crescent male quartet; 9:50-10:35, musicals; 10:35-10:45, May Breen and Peter DeRose; 10:45-11, Charles DeLuman, baritone; 11-12, Meyer Davis' Lido-Venice orchestra. WEEI, Boston, Mass. (348.6), 7:30 p. m., to be announced; 8, Neapolitan, Ili Cream company; 8:30, Sager's half hour of hospitality; 9, to be announced; 10, American House Marimba band; Scotty Holmes' orchestra; 11, talk, Malcolm Nichols. WGBS, New York, N. Y. (315.6), 3:30-3:50 p. m., interview, Mary Borden; 6-6:30, Uncle Geehee; 6:30-7:30, Anzell's orchestra. WGP, New York, N. Y. (315.6), 3-3:15 p. m., Nate Osborne and Eddie Meredith, songs; 3:15-3:30, studio program; 3:30-3:45, Leslie McLeod, tenor; 4-4:15, Sam Weber, pianist; 4:15-4:30, Clarence Profit and Patty Carter, entertainers; 4:30-4:45, Charol de Thomeas, pianist; 4:45-5, William J. Rietz, songs; 8-9, Radio Shack hour; 9-9:05, health talk; 9:05-9:15, Frank Gallasi; 9:15-9:25, Shirley Herman, songs; 9:25-9:35, Jimmy Flynn, songs; 9:35-9:45, Della Riordan, baritone; 9:45-10, Vera Rothenberg, pianist; 10-11, Strickland, Club Athlone orchestra; 12-12:30 a. m., Connie's orchestra. WGR, Buffalo, N. Y. (319), 2:30-4:30 p. m., WGR's afternoon program; 6:30-7:30, Clef trio; 8-9, Troop 63, Boy Scouts of America; 9-9:30, Winger's Crescent Park entertainers, "The Old Blacksmith Shop"; 9-10, Gospel Melodists; 10-10:30, "Hilgrim male quartet; 10:30-11, "Thirty Minutes of Something Different," Hewitt Rubber company; 11-11 a. m., supper-dance music, Vincent Lopez Hotel Statler dance orchestra, Harold Gieser, director. WGY, Schenectady, N. Y. (379.5), 6:30 p. m., International Sunday school lesson; 7, Albany Strand theater orchestra, Julius Boxhorn, conductor; Floyd W. Walters, organist; 7:30, health talk; 7:40, comedy drama, "His Family," WGY players, Ten Eyck Clay, director; 10:30, WGY orchestra; Richard Tweedy, pianist. WHAB, Atlantic City, N. J. (275), 7:30 p. m., fashion talk; 8, Seaside hotel trio; 11:15, Strand theater organ recital. WHN, New York, N. Y. (361.2), 6:40-7 p. m., "Sunshine Talks," Billy B. Van; 7-7:30, Club Richman entertainers; 7:30-8, "Cheerful Philosopher," Burr McIntosh; 8-8:30, Colonial Aces; 10:30-11, Roseland dance orchestra; 11-11:30, Radio club orchestra; 11:30-12, Club Athlone orchestra; 12-12:30, Silver Slipper revue and orchestra. WIP, Philadelphia, Pa. (508.2), 6:05 p. m., dinner music, Benjamin Franklin concert orchestra, W. Irving Oppenheim, director; 7, Uncle Wip. WIAR, Providence, R. I. (305.9), 8 p. m., musical program; 9, Maine Creamery entertainers; 11, Providence Hilton hotel dance orchestra. WJR, Detroit, Mich. (517), 7 p. m., studio orchestra, Jean Goldkette; 8, Summerfield and Hecht. WKAQ, San Juan, P. R. (340.7), 8-9 p. m., entertainment, Porto Rican Atheneum. WLIT, Philadelphia, Pa. (394.5), 12:02 p. m., daily amance; Stanley theater organ recital; Arcadia cafe concert orchestra; 2, Arcadia cafe concert orchestra; 2:30, playlet, students National School of Education and Oratory; 4:30, dance orchestra; 7:30, Dream Daddy's bedtime stories; 8, talk; 8:30, Blue Anchor Inn concert; 10, Arcadia cafe dance orchestra; Morning Glory club concert; Artie Bittong and his Midnight Raiders; Elks' club dance orchestra, Jimmy Jones, director. WLWL, New York, N. Y. (288.3), 8 p. m., talks on literature; special talks. WMCB, New York, N. Y. (340.7), 6-6:30 p. m., Oleott Vail and his Hotel McAlpin string ensemble; 6:30-7:30, Ernie Golden and his Hotel McAlpin orchestra; 7:30-8, "The Right Word," W. Curtis Nicholson; 8-8:30, democratic campaign talk; 8:30-8:50, Ukulele Bob McDonald; 8:50-9, Broadway association; 9-10, Hardman hour of music; 10-10:15, talk, Harry Raines; 11:15-11:45, Donald Blum, dramatic critic. WOR, Newark, N. J. (405.2), 5:15-5:45 p. m., Ziv's Casino orchestra; 6:15-6:30, sports talk; 6:30-7, Man in Moon; 7-7:50, Hotel Shelton orchestra. WRC, Washington, D. C. (469), 10 a. m., women's hour; 12 m., organ recital; J. p. m., Hamilton hotel orchestra; 5, WRC's Foolish entertainers; 6, book reviews. WREO, Lansing, Mich. (285.5), 6-7 p. m., dinner music. WTAG, Worcester, Mass. (268.8), 8 p. m., concert. WTAM, Cleveland, Ohio (389.4), 12-1 p. m., Euclid music studio; 6-7, Euclid music studio. WVIC, Hartford, Conn. (475.9), 6:30 p. m., young people's hour half, Mrs. Mary E. S. Root; 7, Emil Heimberger's Botel Bond trio; 8:30, Laura C. Gaudet, pianist; Benjamin M. Knox, vocal ensemble; 10, Hotel Bond orchestra; 11:30, Hart trio; Frank C. Bradbury, banjoist. WWA, Detroit, Mich. (352.7), 12:05 p. m., Jules Klein's Hotel Statler orchestra; 3, Detroit News orchestra; 6, dinner concert; 8, News orchestra; 9, dance program. WFAB, Lincoln, Neb. (340.7), 5:30-6:30 p. m., dinner hour concert; 8:30-10:30, Doane Colonial School of Music. KFDM, Beaumont, Texas (315.6), 8-10 p. m., Magnolia Petroleum company's refinery band. KFMX, Carleton, Minn. (337), 10-11 p. m., organ recital. KPNF, Shenandoah, Iowa (266), 7 p. m., Sunday school lesson; 7:30, pipe organ concert.

(Continued on page 13)

AN EVENING AT HOME WITH THE LISTENER IN IN EASTERN TIME

Table with 10 columns: Call, Location, Met., Saturday, Sunday, Monday, Tuesday, Wednesday, Thursday, Friday. Lists various radio stations and their broadcast schedules.

FOLLOWING SPORTS THROUGH MIKE

WHAS 'ACTS' WORLD SERIES IN LIFE SIZE

CREDO HARRIS OPENS EYES OF FANS WITH STUNT

Invents Simultaneous Baseball Drama Using Play-by-Play Results and Telephoned Cues

LOUISVILLE, Ky.—Who said there was only one world's series? Perhaps Pittsburgh and Washington citizens are firmly convinced this is true, but no one from Louisville would believe it after having attended the world's series games reproduced here play-by-play, under the direction of Credo Harris, southern gentleman and director of WHAS, the Courier-Journal and Louisville Times broadcast station.

Not a mere electrical scoreboard, not just a pictureless broadcast figured in this unique invention of Mr. Harris, but actual flesh-and-blood teams, dressed in Pirate and Senator uniforms, discarded their initiative and played "dictated" baseball—exactly duplicating every play in every game of the series—to the complete enjoyment of many thousands of baseball fans who jammed the local park to see the free-of-charge WHAS replica games.

How Stunt Was Accomplished

Mr. Harris, whom you can't help but like if you know him, pondered over the idea of giving a better picture—a baseball drama if one may call it that—of the distant series by using the Associated Press play-by-play reports as "lines" and "cues" for his baseball player "actors."

Aided by Chief Operator J. Emmett Graft, he conceived the following plan:

Two Louisville semi-professional teams were appointed to represent Pittsburgh and Washington, and each player was assigned to assume the part of one of the Pirate or Senator team members. The part of Walter Johnson, of course, was very much sought! The teams were uniformed correctly to duplicate the series.

Each player went on the field with a telephone head set over his ears and

Chicago-Penn Next for 'Twin Announcers' Mike

McNamee and Carlin Will Cover East-West Classic

NEW YORK.—Graham McNamee, prominent sports announcer of WEAF, will be at the microphone at Franklin Field, Philadelphia, Pa., on Saturday, October 24, to describe for the Radio audience of WEAF and chain of stations the football game between the University of Pennsylvania and the University of Chicago. This will be the second game of the season to be broadcast by these stations by a new and unusual method of cooperative reporting and announcing with Phillips Carlin acting as observer. Every other week "the Radio twin announcers" will alternate in announcing, on the following Saturday McNamee acting as observer and Carlin describing the Yale-Army game.

player's cap, and wires led down from the head set to the spikes on his right and left shoes. Umpires were also thus equipped.

At each of the nine playing positions, home plate, and the umpires' locations, two copper plates, separated from one another by the usual distance of the feet of a player when at that place, were fastened to the ground. These plates were connected in parallel by wires to one of the dugouts, where a telephone transmitter and an Associated Press sounder were located.

A Specimen Play

The game was called. (The umpires have announced the batteries.) "Walter Johnson pitches," says the Associated Press telegraph operator. The director of the Louisville replica, also in the dug-out, speaks the same message into the transmitter. The players, batter and umpires—with their feet on the copper plates—get the message and wait. Ah, there it is—the A. P. man says, "Ball one." The Louisville director speaks the same message into the telephone transmitter. The players hear and the action starts!

No Ball Is Used.

"Walter" pitches an imaginary ball. No ball is used! The "Pirate" batter, swaying his bat, dodges a bit but does not

MOUNTAIN STATION TO GIVE ALL GRID SCORES

Associated Press Wire Service to Be Broadcast

DENVER.—With football enthusiasm running highest in years, KOA, here, recently announced a tie-up through the courtesy of the Denver Post and Associated Press whereby final results every Saturday are to be flashed for a wide-spread audience of broadcast listeners.

East to west, returns from every important game of the day will be reviewed in rapid fire succession beginning at 6 p. m. mountain time. This feature, continued throughout the season, will include returns from the Army-Navy classic and the Big Three, Big Ten and Pacific coast clashes. Likewise, highlights of all games in the Rocky Mountain conference will be reported.

Football is a very popular sport in the Rocky Mountain region.

500 Gold Miners Hear KGO Broadcast the World Series

DENVER.—Five hundred hard-rock miners at the west portal of the Moffat tunnel, being constructed high up in the Rockies, followed the opening game of the world's series over KOA, station here of the General Electric company.

This group, isolated on four sides by almost impenetrable mountain barriers, is believed to be the most singular assemblage of Radio-baseball fans "watching" the Pittsburgh-Washington struggle for baseball supremacy.

strike. The "Washington" catcher catches the imaginary ball, and the umpire raises his finger. "Ball one," he shouts.

The crowd cheers, hoots or does whatever a bunch of enthusiastic ball fans are supposed to do. The "ball" is then returned to "Walter" to await the next telegraphed, then telephoned, play-by-play instructions.

That is enough to give an idea of how the whole stunt was carried out. Admitted free of charge by the owners of WHAS to see such an exact duplicate of a \$50-a-seat proposition, is it any wonder that Credo Harris is the idol of Louisville today?

And to do a bit of the usual, as well as the unusual, WHAS at the same time broadcast the series.

Football Broadcasts

Saturday, October 24

- Ames-Washington U. (of St. Louis), WOI (270).
- Argonauts-Hamilton Tigers, CFCA (356).
- Cincinnati-Dennison, WSAI (325.9).
- Detroit-Quantico Marines, WJR (517).
- Harvard-Dartmouth, WEZ (333.1).
- Michigan-Illinois, WGN, (370.2).
- Minnesota-Notre Dame, WCCO (416.4).
- Nebraska-Kansas, KFAB (340.7).
- N. M. State College-Sul Ross College, KOB (348.6).
- Northwestern-Tulane, KYW (535.4), WBBM (226), WMAQ (437.5).
- Ohio State-Iowa State, WEO (293.9).
- Oregon-California, KGW (491.5).
- Pennsylvania-Chicago, WEAF (491.5), WGR (319), WGY (379.5), WIP (508.2), WJAR (305.9), WJZ (454.3).
- Pittsburgh - Carnegie Tech., KDKA (309.1).
- Washington-Whitman College, KFOA (454.3).

Navy Heads and Heroes On Special Broadcast

Secretary Wilbur, Shenandoah Survivors and Others to Talk

NEW YORK.—Navy day on October 27 will be celebrated by WEAF and a chain of stations by a special program from 7:30 to 8:30 p. m., eastern time. Four members of the navy department, whose names are occupying the public attention at the present time, will speak.

Secretary of the Navy Dwight C. Wilbur will introduce the succeeding speakers after his own address; Commander John Rodgers, who was in charge of the PN6-No. 1 in its memorable transpacific hop, which was given up for lost, and Lieut. Commander Rosendahl, survivor of the ill-fated Shenandoah.

The program will be carried by telephone lines from Washington, D. C., to the various stations broadcasting it.

The New Radio Book

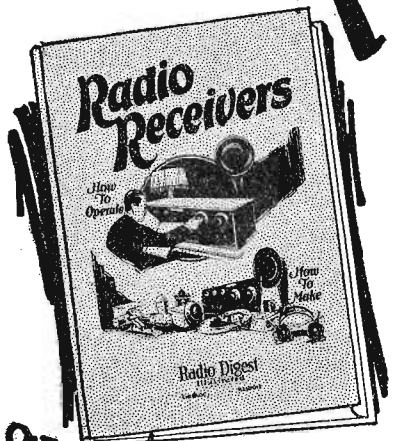

How to understand radio, assemble circuits, operate sets, improve reception,

Whether you purchase a complete installation or build your own, this book will be valuable to you. For the non-technically inclined, there are pages on antennas, care of batteries and station schedules. The experimenter will find scores of circuits, sets and constructional hints. FREE with a year's subscription to Radio Digest.

RADIO DIGEST 10-24-25
510 N. Dearborn St., Chicago, Ill.
Enclosed find five dollars for one year's subscription to Radio Digest including FREE the New 124 Page Radio Book called "Radio Receivers—How to Operate and How to Make." This offer good on subscriptions sent directly to this office, not through agents or agencies.
NAME
ADDRESS
CITY STATE

B-T "COUNTERPHASE"

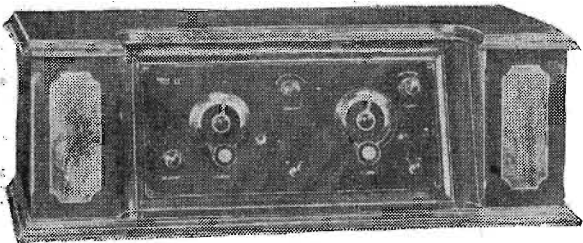

A Set with a Circuit A Circuit with a Pedigree

By All Odds the Finest—

that can be built. Not merely to "look nice" but to perform. The famous B-T "Counterphase-Six" is a set that is built behind the panel to give satisfaction to the man in front.

It is built in the B-T factories from B-T apparatus using an exclusive, patented B-T circuit—the only one that provides a means of operating with equal efficiency on all broadcast wave lengths. You owe to yourself to at least investigate the "Counterphase." *It is by all odds the finest you can buy.*



"THE BEST TRANSFORMER WE EVER TESTED"

is the report from a leading laboratory. B-T engineers decided that better audio transformers were necessary to do full justice to B-T circuits and apparatus, so they designed the B-T "Euphonic."

In addition to being a superior transformer the "Euphonic" has an exclusive mechanical feature that permits any type of mounting—base-board, sub panel or side—with terminals always in correct position for wiring. This feature eliminates howling and distortion due to leads being too close together.

For better tone and convenience in building buy B-T "Euphonic."

See us at the Chicago Radio Show, Coliseum, Nov. 17-22.

Send for literature describing all B-T products. Include 10 cents for "Better Tuning"—the greatest help to the set owner or builder ever published.

BREMER-TULLY MFG. CO.

532 S. CANAL ST.

CHICAGO, ILL.

Radio Digest Illustrated

Published by the Radio Digest Publishing Company, Inc.
510 North Dearborn Street
Chicago, Illinois
Telephones: State 4372, 4373, 4374, 4375

E. C. RAYNER, Publisher

Eastern Office, Park-Lexington Building, 247 Park Ave.,
New York. Telephones: Ashland, 8144, 8145, 8146

Member of the Audit Bureau of Circulations



241
PUBLISHED WEEKLY

SUBSCRIPTION RATES
Yearly in U. S. and Possessions and Canada, \$5.00
Foreign postage, \$1.00 additional. Single copies, 10 cents.

Vol. XV Saturday, October 24, 1925 No. 3

Radio vs. The Newspaper

WHAT of the future of the "spoken" press and the printed newspaper? Will Radio broadcasting, the spoken press, do away with the necessity of printed newspapers?

The question is not so important to the public at the moment, but is one which is very debatable, and furthermore presents some interesting crystal gazing.

We believe that as time goes on broadcast stations are destined to take the place of daily newspapers for the dissemination of spot news. We are firmly convinced, however, that the daily newspaper will not be entirely replaced by the broadcaster. Why?

First, it would take too long for an announcer to read the day's news in its entirety, including all local items, to the Radio audience. The broadcaster would have to read a morning edition, an afternoon edition, perhaps an extra, and an evening edition of spoken news before the entire audience would be reached. This would lead to repetitions, and more valuable time would be consumed. The newspaper has the advantage here, because the headlines, taken in at a glance by a reader, so condense the news that the reader can keep well in touch with world, national and local affairs in about fifteen minutes of time. Then the reader can go back to the stories whose headlines interested him, and read thoroughly or briefly, as he desires, the items he wishes to know more about. He cannot do this with the spoken press. He must stand by and listen to all that is read by the announcer, which process consumes more time than the hurrying human beings of today have at their command.

Second, the man who has not time to listen in for the news at the time it is being broadcast, will later read the newspaper of necessity for his information.

Third, photographs are not yet being broadcast and received by the average citizen. If such a simple and cheap process is invented that it becomes generally accepted by the public, newspapers will still have the advantages mentioned as first and second reasons for the printed paper's continued existence. That is, pictures desired by the reader or listener could not be hand-picked by the Radio listener, and the man who misses the pictures would refer to the printed paper.

Fourth, magazine sections, which are so common in the printed daily paper, can hardly find enough time on the air for their full exploitation. Magazine sections are in the printed paper for various classes of people. Art lovers, drama supporters, motion picture fans, readers of books, and many other classes are appealed to by these sections. Radio, with its universal appeal, can hardly afford to devote enough time to any one of these classes to compete with the thorough handling of the daily paper.

The conclusion is, therefore, that broadcasting stations, while an ally and aid to the daily paper in the dissemination of spot news, can hardly be expected to ever take the place of the latter which is so important in our daily lives.

Regarding Silent Nights

SILENT nights, as recently adopted in the Chicago area, are a splendid thing for similar areas—wherever they may exist. New York, with almost a parallel situation to that of Chicago, has never tried a silent night. We venture to say, that if New York area stations remained silent for one night, advertised in advance, the metropolitan public would insist upon its weekly repetition.

Los Angeles and San Francisco might also get together and give coast fans a real chance to "pull them" over the mountains or from across the Pacific where Hawaii, Japan and Australia are broadcasting.

While the number of localities afflicted with the ill of too many enthusiastic stations, is of course limited, we believe that the listeners and dealers in these localities should get together and ask their stations for a trial of the idea. The night picked, of course, should not be the same as Chicago, which is Monday night.

Some day, perhaps, transmission and reception will be so perfected as to make silent nights unnecessary and undesirable, but experience has shown their desirability at present in congested ether localities.

RADIO INDI-GEST

"Whadda You Say?"

When a station comes in weak,
So you scarcely hear them speak,
And you know 'tis new, and very far away;
When it's on the point of telling,
The call letters and its dwelling,
Then some nearer station starts a band to play,
"Whadda you say? Whadda you say?"

When the ball score you would get,
On the game you have a bet,
And your dial is set for it exact and true;
Static makes of it a fine hash—
"Boston—" Crackle! Bang! "New York—" Crash!
And there's not a blessed thing that you can do,
"Whadda you say? Whadda you say?"

GEORGE.

Useless Facts and Figures (Another Terrible Installment)

If all the doughnut coils used in sets built in October, 1925, were stacked in one huge pile, some manufacturer of triangular or hexagonally wound lesser loss coils would get jealous and knock the pile over before it reached the moon.

Marconi confesses he is bewildered by the amazing growth of Radio. The only thing that amazes us is how our first homemade set managed to work.

Let your battery run down far enough and even static won't be heard through your receiver.

Saxophone solos are excellent in a Radio studio but are seldom appreciated in a flat building.

After looking over the latest micrometer dials brought out this fall, we have come to the decision that with several micrometer verniers for these micrometer dials, one will be able to sit all night and tune without hitting a single station.

GOOFY GUS.

Distilled

BY THE THIRD TROMBONE PLAYER

Good gosh, don't that guy Dielectric in the next colyum write some classy critiqueisms? You know me and him went to Correspondence School together. We both graduated only he got six pages in the book farther than I got, that's why he can use bigger words than me. He ain't bad, he ain't. I remember the stirring moment when the mail man handed us our diplomas. Old Condensed and I felt pretty solemn you bet. I felt like crying but Condensed slapped me on the back and said, "Old man, I'll never, never use them big words on you. You wouldn't understand them anyhow and you might think they was athema or something." With this the noble creature loaned two bucks off of me and left for Chicago to take charge of The Radio Digest Sporting Section. I sure miss them—I mean him.

Sure was a good speech from WBEAF. Old Dave Scarehoff was telling the world how thru strict economy and personal sacrifice he was able to bring down the price of Radio tubes from \$9.50 to \$2.50. Why, the old boy went without champagne for weeks, the Ampico hasn't been tuned for a month and there hasn't been a new Brussels carpet layed in his summer home on the Maine coast since last September. "Yes, sir, all for the good of the great American Radio public," sobbed Dave at the conclusion of the talk. Some of the nasty people who sell tubes for 68 cents came in for a few hard words, too.

Me and Condensed took in the Radio World's Fair and Grand Central Palace. Condensed was pretty well crooked—asked one of the exhibitors whether he handled any low loss rheostats. Next he spied a young lady exhibiting some sockets. He ups and introduces himself as the big condenser man from Butternut, Wisconsin. She gave him a stare that would paralyze a W. E. V. T. 2. Meantime, while this was going on, I helped myself to some parts on the counter. Personally, I felt relieved with all the parts in my hand—potential missives of displeasure—that no one knew my identity. Think of the notoriety of it if me and Condensed would be pinched for Drunk and Disorderly. I don't give a hoot about myself but what about my relatives?

That stuff of Overseer Revolver trying to bribe me into writing some snappy critiqueisms about his programs is the bunk. Condensed is jealous of me and told the City Editor I was seen with the Overseer in Fritz Gust's Weinstube and that he was buying me drinks. He never bought me no drinks. Condensed is mad on me since the day I told him the only thing condensed about his job was the sense in his articles. Us authors sure have our troubles.

But the stars are setting and the caravan starts for the dawn of nothing, so I will make haste and bring this complement to a close.

Your old straight line friend,
THE THIRD TROMBONE PLAYER.

HEAR YE! HEAR YE! LISTEN!

Coming Soon. The First Time in Any Type.
RADIO EPITAPHS

by
THE THIRD TROMBONE PLAYER

Will positively be shown in this space and this space only (if that New Bedford Radio editor does not copy it).

Order your seats in advance.
Big Street Parade at ten o'clock FREE.

News of the Week

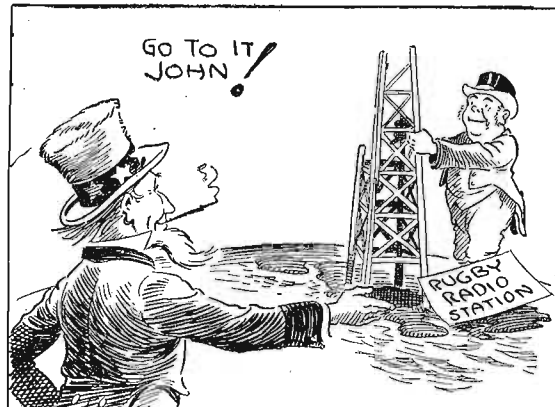

CHICAGO'S SILENT NIGHT

THIS GENT DIALED 34 STATIONS SINCE CHICAGO WENT SILENT



THIS ANNOUNCER WAS SO LONESOME HE HAD TO USE THE TELEPHONE, YES SUH!

Condensed BY DIELECTRIC

Increasing comment is heard from the listeners in on the programs which feature some manufacturer's product under the thin guise of entertainment, either in the form of an orchestra bearing the trade mark of the producer, or a group of singers appearing as the "Halitosis Four," etc. There seems to be no dissatisfaction with the entertainment, but there is a growing dislike of hearing it preceded and interspersed too much with repetitions of the brand name of some household commodity. Where the introduction contains no more extensive statement than precedes a Formica concert, fans are little disturbed. Also there is favorable opinion of advertising concerts when diversified, as many of these are. We have an agreeable impression of the Lyric male quartet which sang through WLW, Cincinnati, in spite of the fact that it was mounted on a Formica platform.

Dance music is much the same wherever heard these days for few stations have poor orchestras on their programs for this type of music. It may have been the mood which favored my reaction to a dance hour presented by WMBF, Miami. Anyhow, those boys did inspire one to perform gracefully and continuously on a waxed floor with the strains of music pervading the room. Down where a square foot of soil costs a year's output of receiving sets, there is real dance music, yes sir.

Our dance music is usually thrust upon us, either unheralded from some hotel or ballroom by means of remote control or from the studio with very short announcements. Now comes Don Clark with his La Monica orchestra, broadcasting from KNX each Tuesday evening, who takes up fifteen minutes of his hour of broadcast to explain modern dance music. He not only does this with words but goes back and plays some old jazz tunes to illustrate his points. How many can remember that first jazz number, "The Livery Stable Blues?" At any rate, Don Clark, who was soloist with Paul Whiteman for some time, is making a sincere effort to place and microphone the modern twelve-piece dance orchestra so it will reproduce better, which is something that not many have tried to do. I enjoyed particularly his Symphonic Waltz. Tune in next Tuesday evening at seven, Pacific time, if you can and see if you like him too.

WHT, Chicago, is to be congratulated for one thing at least, the announcers waste no time between numbers and what is announced comes over distinctly. In listening to an orchestra from this station one evening a short time ago I could find no fault with the transmission, nor with the musicians themselves. The tempo was exactly respected by each choir in the orchestra—and that is a matter some organizations might profitably ponder, and improve. One sad feature was presented, for which no one but the composer is responsible, and that was the desecration of that beautiful meditation from Thais by jazzing it. Let these classics alone despite the Third Trombone Player.

WEAF, New York, attempted the task of presenting Henrik Ibsen's Peer Gynt with music by Grieg. This came in the regular Eveready hour of entertainment and was a welcome diversion. So far as the music was concerned there was the expected pleasing rendition, but when we speak of the work of the actors it is to record a dissatisfaction. "Peer's" enunciation was baffling and spoiled the trend of action, therefore, while some of the back scene speaking parts were barely audible. Graham was an indispensable adjunct with his picturization of the scenes.

The Grand Prix Eight Tube Super-Heterodyne

Part I—What Is in It and Why

By James McDonald

LIKE all other Radio fans that build their own sets, the writer has long had the idea of building a real super-heterodyne, using the very best parts obtainable, designed for compactness and presenting a symmetrical good-looking front panel. Fans are always asking, "What parts do the old-timers use—the men on the inside that know what is what? I want to build a set that will be O. K. all the way through." Grand Prix is presented as that set; a different group of parts might be picked as being equally good, and the resultant set might be just as efficient as Grand Prix, but it would be no better. The writer knows all the parts available inside and out and knows personally most of the manufacturers and designers of parts, and this selection is made without bias and without fear of criticism from anyone. You have, in every unit, the highest efficiency possible and Grand Prix can be placed in competition with any super made for range, volume or appearance.

The panel size is but 7 by 18 inches and, unless you have tried designing a receiver, you cannot appreciate what a lot of juggling around of parts on panel and sub base it required, keeping in mind all the time both symmetry and short leads. However, it finally worked out that the two condenser dials came on opposite ends of the panel, one for the loop tuning and one for the oscillator, with the potentiometer and rheostat in between and the oscillator coupling control at the top. The filament switch is in the center near the bottom, the second stage jack for DX loud speaker operation is in the lower left corner and the first stage jack to the right.

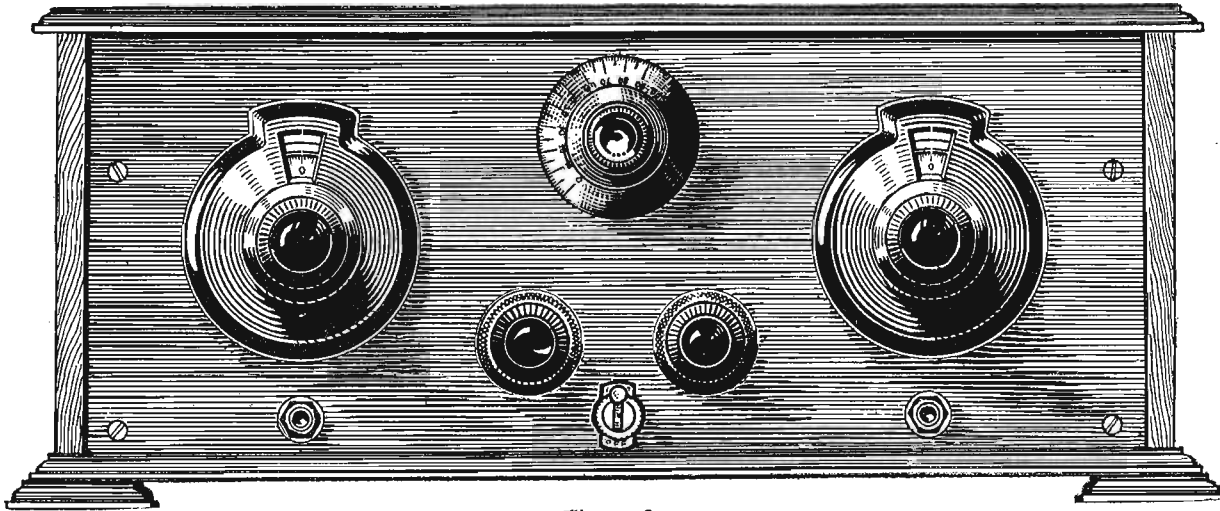

Figure 1

The Cardwell condensers are of the straight line capacity type, as the writer has the highest respect for Cardwell engineers on condenser construction and they have designed a remarkably efficient unit of the S. L. capacity type. The losses in one of these condensers are too low to be measured since they are lower than those of the precision apparatus of a laboratory. With a maximum capacity of .0005 mfd. the minimum is but 18 mmfds. at zero setting. There is no tendency of the rotor plates to slip at low settings due to overbalancing which is sometimes the case in condensers of the S. L. frequency type. Used with the Cardwell dial, the user has all the tuning advantages of the S. L. frequency type in that stations are well spread out at the lower wave lengths.

Equitrol dials are peculiar units in that they provide varying vernier ratio between minimum and maximum with the result that a straight line capacity condenser gives straight line wave length readings and over a 360-degree scale. It was largely

because these dials were available that the writer used the straight line capacity condensers and thus got the efficiency and desirable features of those condensers. Equitrols turn smoothly and provide logging space over a wide circumference.

Amsco potentiometer and rheostat are chosen because they are compact, smooth, attractive and sturdily made units. The wire on the potentiometer is not so fine that it is liable to cut or break at a vital moment and the rheostat is a power unit made with all the care of its higher resistance brothers in the Amsco line. Little reason need be given for the switch used; it is a Cutler-Hammer, simply and dependably designed, with a snap to its action that means positive make and break. Carter jacks have always given the writer excellent service and they are used by a large number of manufacturers of complete sets. Springs are always correctly shaped so that you do not have to use brute force to get a plug in and the contacts always "make" when the plug is withdrawn.

variable coupling of the pick-up coil.

Since there is so much to a super-heterodyne it is very difficult to locate trouble when it occurs and the writer decided to eliminate all possibility of trouble in the sockets by using Bremer-Tully of the new type. In this type UL socket, the desirable side cutting action of the springs on the tube pins is retained from the old socket with the additional feature that either the UV or UX tubes can be used. Then too, when a soldering lug or wire is secured under the binding posts, it is in direct contact with the spring which has dug into the side of the tube pin. There will be no trouble hidden under tube bases.

Precise parts play a large part in the success of this outfit. The Multiforner unit includes four transformers which replace the filter and three long wave transformers usually installed as separate units in the super. These are perfectly matched, securely sealed against moisture, protected against injury by a sturdy case

(Continued on page 18)

LIST OF PARTS

2 Cardwell .0005 mfd. Condensers, 123-B	A. B. Cardwell Mfg. Co., Brooklyn	7.00
2 Cardwell Equitrol Dials	A. B. Cardwell Mfg. Co., Brooklyn	7.00
1 Precise Multiforner Unit	Precise Mfg. Corp., Rochester, N. Y.	20.00
2 Precise Audio Transformers	Precise Mfg. Corp., Rochester, N. Y.	15.00
1 Pair Precise Brackets	Precise Mfg. Corp., Rochester, N. Y.	2.00
1 Amsco Rheostat, 2 Ohm	Amsco Products Co., New York City	1.35
1 Amsco Potentiometer, 400 Ohm	Amsco Products Co., New York City	1.35
8 B-T Sockets	Bremer-Tully Mfg. Co., Chicago	6.00
1 Lincoln Oscilloscope	Lincoln Radio Co., Chicago	6.50
1 C-H Toggle Switch	Cutler-Hammer Mfg. Co., Milwaukee	.60
1 Carter Jack, No. 104	Carter Radio Co., Chicago	1.00
1 Carter Jack, No. 101	Carter Radio Co., Chicago	.70
2 Carter Imp Phone Tip Jacks	Carter Radio Co., Chicago	.70
1 Celeron Panel, Mahogany, 7x18	Diamond State Fibre Co., Bridgeport, Pa.	2.40
1 Celeron Panel, black, 7x17½	Diamond State Fibre Co., Bridgeport, Pa.	1.70
1 M-B-G Knock Down Cabinet, 7x18x10	Express Body Corp., Crystal Lake, Ill.	3.10
2 Dubilier 601-G Grid Condensers, .00025 mfd.	Dubilier Radio & Cond. Corp., N.Y.C.	.90
1 Dubilier .006 mfd. Fixed Condenser	Dubilier Radio & Cond. Corp., N.Y.C.	.75
1 Dubilier .002 mfd. Fixed Condenser	Dubilier Radio & Cond. Corp., N.Y.C.	.40
1 Dubilier By-Pass Condenser .5 mfd.	Dubilier Radio & Cond. Corp., N.Y.C.	.90
2 Daven Cartridge Leaks, 2 Megohm	Daven Radio Corp., Newark, N. J.	1.00
1 Belden Battery Cable	Belden Mfg. Co., Chicago	.75
Total Cost.....		\$81.10

BIG PRICE REDUCTION

Fultone
Trade Mark

THE FORD of LOUD SPEAKERS

\$6.50

Fultone Loud Speaker has conclusively proven to the radio world that a reproducer could be made and sold at \$6.50 which would handle music or speech in volume as perfectly as any speaker at any price. The horn is solid, non-ringing and wide-throated enough to handle the powerful reproduction from super-heterodyne or reflex. The adjustable diaphragm permits matching Fultone to any receiver and "B" battery voltage.

Either speaker or unit will be shipped on a satisfaction or money back basis on receipt of price in money order or currency. The coupon is provided for your convenience in ordering if your dealer cannot supply you.

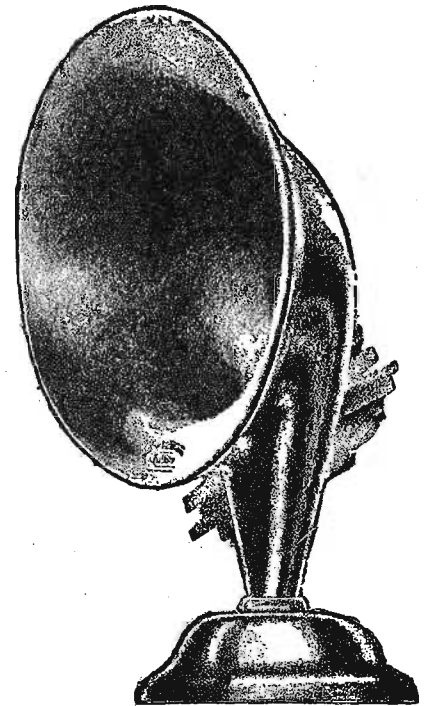

Fultone
Trade Mark

LOUD SPEAKER UNIT

\$3.00

This unit is the secret behind the unparalleled success of Fultone Speaker. Fine wire are protected from injury by a back of which adjustment is made by

Tear Off, Fill in, Mail Now

HALL & WELLS, Inc. 128 N. Wells Street, CHICAGO, ILL.

Enclosed is \$.....for which ship me () Fultone Speaker.....() Fultone Unit at once, my money to be refunded if I am not satisfied and return this merchandise within 5 days.

NAME.....

ADDRESS.....

CITY AND STATE.....

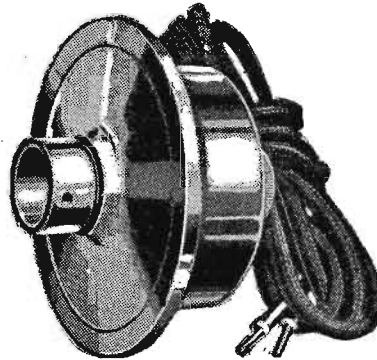

Its large diaphragm and bobbins of heavy nickel-plated case through the means of a special key. The pole pieces are not made from a solid piece of iron but are assembled from 15 laminations of carefully chosen steel.

Use on Your Phonograph
Edison Adapter.....25c
Columbia or Pathe.....20c
Brunswick.....30c

HALL & WELLS, Inc.
128 N. Wells St. Chicago, Ill.

A FACT!

The only man who doubts that a 3-tube set can give better results than a 5-tube set, is the man who has never made a performance comparison between the Crosley Super-Trirdyn and the best 5-tube set built.

Super-Trirdyn Regular, \$45

THE CROSLEY RADIO CORPORATION, Cincinnati, Ohio

CROSLEY RADIO

BETTER · COSTS LESS

GRAND PRIX SUPER-HET

Continued from page 17)

and the whole is provided with conveniently located terminals for connections to tube sockets. The audio transformers are of the new improved type with large core and primary. No distortion was noticeable, of either low or high notes, by competent critics listening to classical music. The cases provide more than adequate shielding which permits comparative crowding of the parts. Precise brackets are solid yet light and the set, as built by the writer, has a solid feel to it, when picked up by either panel or sub base, that is reassuring. These brackets are well worth their slightly higher cost.

Some might consider the addition of regeneration, by means of a split loop and a midget condenser, a desirable feature, but the writer is inclined to believe that, with the other parts used, this would be of little benefit and might even be detrimental. One of the chief disadvantages encountered is the hand capacity to be noticed, at times, on the loop tuning dial when regeneration approaches oscillation. In Grand Prix, both condenser rotors are at filament potential and tuning is unaffected by the approach of the hands. Many builders will, at first thought, steer clear of building and finishing their own cabinet but the writer found this rather interesting and not nearly as difficult as many would have us believe. Incidentally, it brought down the cost for this item tremendously.

(This super, made of nothing but the very best parts obtainable and used by Mr. McDonald to listen to just about anything he chooses whenever he chooses, can be readily duplicated by Radio Digest readers. Nothing is left to the reader's judgment and every hole is drilled by directions and every wire placed is both described and pictured. Next week, Mr. McDonald will detail panel and sub base drilling, and the complete assembly.—Editor's Note).

Germans Develop New Mike with Wide Frequency Range

BERLIN, Germany.—A new type of microphone, capable of handling a wider range of frequencies with more faithful reproduction, has been developed here. Tests indicate it to be superior to the best of American designs, it is said. Several American stations have placed orders for the new "mike."

Friday, October 30

(Continued from page 14)

- KFVE, University City, Mo. (240), 6:30 p. m., amusement review, Romaine Fielding; 10, Jack, Jim and Tom, entertainers; Orchestra Romaine.
- KMA, Shenandoah, Iowa (252), 9-11 p. m., musicale, May Seed and Nursery company.
- KSD, St. Louis, Mo. (545.1), 7:30 p. m., Commerce hour tabloid presentation of "Faust," Gwilyn Miles, director.
- KTHS, Hot Springs National Park, Ark. (374.8), 9:10-9:15 p. m., farm talk, E. B. Matthew; 9:15-10, concert, New Arlington hotel orchestra; cello and piano duets; string trio; 10-10:10, organ selections, Louis Culp; 10:10-10:35, Bennie Ford's DeSoto dance orchestra.
- KYW, Chicago, Ill. (535.4), 11:25 a. m., table talk, Mrs. Anna J. Peterson; 6:35-7, children's bedtime story; 7-7:30, dinner concert, Congress hotel; 10-12:30, midnight revue; Coon-Sanders Original Night Hawks; Albert Ray Malotte, organist.
- WAMO, Minneapolis, Minn. (243.8), 6 p. m., dinner concert, George Osborne's orchestra; 7:05, Minneapolis public school hour, T. P. Giddings, director; 8, Football Pepfest, U. of Minnesota; 10:30, Skyrocket frolic, George Osborn and his Skyrocket orchestra.
- WBAP, Fort Worth, Texas (475.9), 7:30-8:30 p. m., Mrs. D. W. Shivers; 9:30-10:45, Alceen Peterson Duff, contralto; Dorothy Davis, violinist; Annie Mae Hopkins, pianist.
- WBBM, Chicago, Ill. (226), 5:30-6 p. m., Kiddies Joy-Digger club; 8-10, instrumental quartet; Leona Hayes, harpist; Devon comedy four; Lew Russell, Pete Kules, Montmarie orchestra.
- WCCO, Minneapolis-St. Paul, Minn. (416.4), 12 m., Dick Long's Dayton trio; 6:10, Emmet Long's Golden Pheasant orchestra; 7:30, "Why I Believe in the Community Fund," Joseph Chapman; 7:45, farm lecture; 8, blood pressure, Minnesota State Medical association; 10:05, Dick Long's Nankin cafe orchestra.
- WOAF, Kansas City, Mo. (365.6), 3:30-4:30 p. m., Star's string trio; 6-7, School of the Air, address; Tell-Me-a-Story lady; Trianon ensemble; 8-9:30, varied musical program, Star's Radio orchestra; 11:45-1, frolic; Merry Old Chief, Plantation players, Coleman's orchestra; Eddie Kuhn's K. C. Athletic club orchestra.
- WEBH, Chicago, Ill. (370.2), 7-8 p. m., Oriole orchestra; Uptown theater; 9-10, Oriole orchestra; Katherine Forbes, soprano; Reulah Ladon, violinist; 10-11 a. m., Oriole orchestra; stories, Wayne Myers; Ray Sualil.
- WENR, Chicago, Ill. (266), 6-7 p. m., dinner concert, Rambard lyric duo; Russell Hendrickson, cellist; Marie Tutley; 8-10, popular program; Frank Westphal and his All-American Pioneers; Grace Hersch, popular songs; Harmony four; Moran and Alt, Hawaiian guitarists; 12-2 a. m., frolic, banjo and saxophone duets; twin piano numbers, vocal selections.
- WFAA, Dallas, Texas (475.9), 12:30-1 p. m., address, Dr. Horace M. Whaling; 3:30-4, Sears-Roebuck Agricultural Foundation home-makers' hour; 4:30-5, woman's literary hour; 6:30-7:30, Hauulea Hawaiians; 8:30-9:30, Lilla Lucile Griffin.
- WGN, Chicago, Ill. (370.2), 12:40 p. m., Drake concert ensemble, Blackstone string quintet; 2:30, artist series, Lyon & Healy; 3, "The Refectory Table," Walter Murray; 3:30-4:15, tea time music, Marshall Fields tea room orchestra; 6:30-7, Drake concert ensemble, Blackstone string quintet; 8-9, WGN string trio; 10-11, Jack Chapman's orchestra; Blackstone hotel dance program.
- WHAD, Milwaukee, Wis. (278), 6-7 p. m., Arthur Richter, organist; 7:05, Bill Juhre's Radio Cartoon game; 8:30-10, Wisconsin theater revue.
- WHAS, Louisville, Ky. (399.8), 4-5 p. m., special program, Henry S. Currie, readings, Courier-Journal, the Louisville Times; 7:30-9, Keith Kamard and his Kentucky Ramblers.

- WHB, Kansas City, Mo. (365.6), 2-3 p. m., Sweeney Radio trio; 7-8, Sweeney Radio orchestra.
- WHOI, Des Moines, Iowa (520), 7:30-9 p. m., Des Moines university conservatory of music; 11-12, dance program.
- WHT, Deerfield, Ill. (399.8), 6 p. m., classical program; Genevieve Burnham, soprano; Bob York, tenor; Grayling's string trio; Al Carney, organist; (238), 7:45-9:15, musical features; (400), 9:30, Loftis half hour of music; Freddie Whitmer, pianist; Samuel Rice, tenor; Oscar Heatter, tenor; Pat Barnes, tenor; Hector Baum, pianist; Husk O'Hare's orchestra; 12, Pat Barnes "Your Hour League," Al Carney.
- WJAD, Waco, Texas (352.7), 8:30-10 p. m., surprise program, Mrs. G. A. Von Blutcher, director.
- WJJD, Mooseheart, Ill. (302.8), 6-6:30 p. m., Howard Peterson, organist; 6:30-7, Belmont trio; 8-9, program, Mooseheart children; talk, M. P. Adams; 10-11, Senator Keessinger; Jean St. Anne, French baritone; Christian A. Grimm, Emma Bevensen Butler; organ selections.
- WLIB, Elgin, Ill. (302.8), 7-8 p. m., dinner concert, Drake concert ensemble; Blackstone string quintet; 9-10, Fred Hamm's orchestra; organ recital; 10-11, Jack Chapman's and the Blackstone hotel dance orchestras; jazz artists; 1-2 a. m., Chapman's orchestra; Blackstone hotel dance orchestra, jazz.
- WLS, Chicago, Ill. (344.6), 6:30 p. m., Ralph Emerson, organist; 7:20, WLS studio trio; 8, KFD program; 9, Ford and Clem; 9:15, Radio-Heaver hour; Homer Kudeheaver; Vivian Trupp; 10-11, Hickey and Johnson.
- WLW, Cincinnati, Ohio (422.3), 12:15 p. m., organ concert.
- WMAQ, Chicago, Ill. (447.5), 12:25 p. m., Y. M. C. A. forum; 2, "Shut In" program; 4, fashion talk; 4:30, Rush Conservatory of Music; 5:30, Child Life stories; 6, Chicago theater organ; 6:20, Family Altar league; 6:30, Wide-Awake club program; 8, musical lecture, Mr. and Mrs. Marx E. Oberdorfer; 8:30, Whitney trio; 9, U. of Chicago lecture; 9:20, Elizabeth Stokes, soprano; 9:45, Christian Endeavor topics.
- WMBB, Chicago, Ill. (250), 7-8 p. m., Beatrice Teller, Joel Lay; Jean St. Anne, Florence White Rush; 9-11, Trianon orchestra; Morey Alswang, Jack Murman, Cecil & Esther Ward, Stokes & Agne, Edward Hines.
- WOAW, Omaha, Neb. (520), 6 p. m., music review, Hester Bronson Cooper; 6:30, Gilbert Jaffy and his Little symphony; 7:10, sport talk, Ivan L. Gaddis; 9, De Luxe program.
- WOC, Davenport, Iowa (483.6), 4-5 p. m., Crescent orchestra; 5:45-6, chimes concert; 6:30-6:50, Sandman's bedtime stories; 8-9, musical program, artists, Clinton, Iowa, Eleanor Moore, director.
- WOK, Chicago, Ill. (217.3), 12-2 p. m., Banks Kennedy, organist; Thomas B. Stephenson, tenor; Marianne Powell Babcock, soprano; Elsie C. Stephenson, pianist; 6-7, Ed Kemp, tenor; Jean Carlson, soprano; Kenyth Dunn, pianist; 10-1, Harry Davis, tenor; Harriet Lee, contralto; Herman Simiko, violinist; Haymakers trio; Berger Weidberg, tenor; Rosemary Hughes, soprano.
- WORD, Batavia, Ill. (275), 8 p. m., Webster hotel concert trio; 8:15, Uncle Dan; 8:30, Chicago and North Shore Electric and R. R. company; 9:30, speaker.
- WOS, Jefferson City, Mo. (440.9), 8 p. m., "The Measure of a Man," Samuel M. Jordan; Missouri Christian church orchestra; Mrs. Lena Bell Newkirk, pianist.
- WQJ, Chicago, Ill. (447.5), 3-4 p. m., "A Party for Grandmother," Helen Downing; "Your Home," June Dunham; 7-8, dinner concert; Robt. Williams and his Rainbo Gardens orchestra; Everett Mitchell, baritone; Gertrude Hardeman, contralto; Cecelia Arends, violinist; Johanna Arends, accompanist; 10-11 a. m., Ralph Williams and his Rainbo Skylarks; Muriel Kennedy, soprano; William Richardson, baritone; H. Lucille Long, harmonica player; Ed McInnis, accordionist; Parish and Ward, harmony singers; Eleanor Terry and Marie Polette; Larry Shay and artists; 1-2 a. m., Ginger hour.
- WSAI, Cincinnati, Ohio (326), 7 p. m., Larkinities; 7:30, pop concert; 8, WEAF; 9, Silvertown Cord orchestra.
- WSB, Atlanta, Ga. (428.3), 8 p. m., Carter Electric company; 10:45, Ansley Rainbow orchestra.
- WSUI, Iowa City, Iowa (484), 12:30 p. m., music.

Mountain Time Stations

- CNRE, Edmonton, Can. (516.9), 8:30-10:30 p. m., Edmonton glee club.
- KFAU, Boise, Idaho (278), 8 p. m., program, Mrs. Edward Bell, director.
- KFWA, Ogden, Utah (261), 9-10 p. m., studio program.
- KOA, Denver, Colo. (322.4), 12:15 p. m., Rialto theater musicale; 3:30, matinee for housewives; 4, fashion review; 4:15, culinary hints; 6:30, Herbert Whitte and his Silver State orchestra; 7:30, review of International Sunday school lesson; 8:10, "Duley," KOA players; KOA orchestra.

Pacific Time Stations

- CNRV, Vancouver, Can. (291), 8 p. m., address, Walter Pratt; 8:50, Westminster string quartet; Belmont cabaret orchestra.
- KFOA, Seattle, Wash. (454.3), 6:45-8:15 p. m., Sherman, Clay and company studio program; 8:30-10, Times studio program; 10-11:30, Eddie Harkness and his orchestra.
- KFPG, Hollywood, Calif. (238), 9 a. m., dad's hour, Dad King; 5-6 p. m., home hour with Georgia Simmons and pupils of Geraldine Kasals; 8-10, KFPG concert orchestra; Charles Beauchamp, tenor.
- KFWB, Hollywood, Calif. (252), 7:30 p. m., microphone brevities; 8-9, Joe Martin's Studio Six dance orchestra, Lottie Humbert, blues singer; Shas. Offenberger, pianist; Charles Beauchamp, tenor; 9-10, program, Paralta photographic studios, Paralta orchestra, Drove Norton Lindsay, tenor; 10-11, Warner Brothers' frolic, direction Norman Manning.
- KGO, Oakland, Calif. (361), 3-4 p. m., Norman Woodside's Metropolitan orchestra; Frank Gibney, tenor; 4-5:30, concert orchestra, Hotel St. Francis; 6-7, dinner concert, Baldwin Piano company.
- KGW, Portland, Ore. (491.5), 12:30-1:30 p. m., Rose City trio; 9-10:30, Sherman, Clay and company; 10:30-12, Hoot Owls; Rose City trio; Pantages acts.
- KHJ, Los Angeles, Calif. (405.2), 6-6:30 p. m., Leigh-ton's Arcade cafeteria orchestra, Jack Cronshaw, leader; 6:30-7:30, history story, Prof. Herzog; Piggly Wiggly girls' string trio; Richard Headrick and Jane Hughes, screen starlets; Uncle Remus, guest announcer; 7:30, Romance of Santa Fe Trail, Miss Gladys De Witt; 8-10, program, Western Auto company, arranged by J. Howard Johnson; 10-11, Art Hickman's Billmore hotel dance orchestra, Frank Ellis, leader.
- KJR, Seattle, Wash. (384.4), 1:15 p. m., organ recital; 2, home help, Bernice Redington; 8:30, Post-Intelligence studio program; 10, Gordon Kilbourne and his orchestra.
- KNX, Hollywood, Calif. (336.9), 5:30-6:15 p. m., Wur-litzer pipe organ studio, Town Tattler; 6:15, travel talk, W. F. Alder; 6:30-7, Atwater Kent Radio orchestra, Paul Finstein, leader; 7-7:30, dinner music; 7:30-8, program, Eastern Outfitting company; 8-9, West Coast theaters by remote control; 9-10, Order of Optonistic Donuts, Davis Perfection Bread company; 10-11, dance orchestra; 11-12, Ray West's Coconut Grove dance orchestra from Ambassador hotel.
- KPO, San Francisco, Calif. (428.3), 1:30-2 p. m., Rudy Seiger's Fairmont hotel orchestra; 7-7:30, Imericks, S. B. Dickson; 8-11, Palace hotel dance orchestra.
- KTL, Seattle, Wash. (305.9), 7-8 p. m., Simonds Saw and Steel company; 9-10, Western Auto Supply company; 10:15-12, Jackie Souder's dance orchestra.
- KWSC, Pullman, Wash. (348.6), 7:30-9 p. m., Jean Fulmer, pianist; Marjory Field, violinist; "The Effect of Sunlight on Bone Formation," C. A. Rust; "The November Farm Situation," R. M. Turner.

Britain Combats Rumors

LONDON.—"Britain at Work" is the title of a series of broadcasts by the British Broadcasting company. These are being given to counteract the impression gained in certain quarters that work throughout the country is almost at a standstill.

Two wonderful new Walnart Tuning Units Assure SELECTIVITY

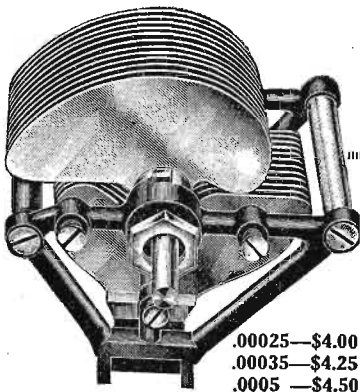

and
Dialog

The World's Smoo-oothest VERNIER DIAL

Another Walnart achievement—and truly, the only practical tuning control. No gears or cams to wear out; nothing to get out of order. Continuous, smooth, fine tuning, station-selecting action from 0 to 100 with absolutely no backlash! And—it requires no extra drilling to attach to any condenser shaft. Put Dialogs on your set—now!

- \$1.25 with black bakelite knob and black dial plate
- \$1.25 with black bakelite knob and silvered dial plate
- \$1.50 with brown bakelite knob and gold finished dial plate

WALNART ELECTRIC MFG. CO.

308 So. Green St. CHICAGO
"Makers of Good Goods Only."

Now—selectivity is no longer a dream. You can enjoy it! These two new Walnart units are the very essence of selectivity.

The Walnart Condenser is not a straight line wave length nor a straight line frequency—but, a station-selecting condenser! Exactly what you have hoped for. Uncrowds all the stations making it easy for anyone to turn to the right condenser setting for any station.

Put Walnart Station-Selecting Condensers in your set. Radio will mean more to you—from that day on.

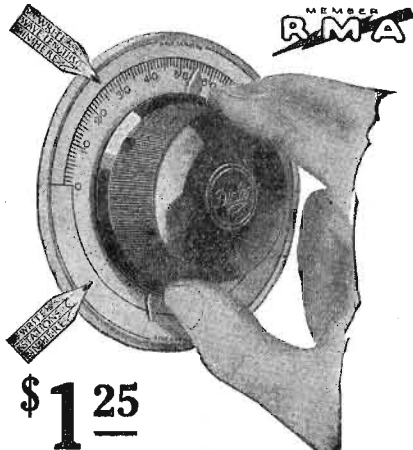

\$1.25

"See our exhibit at the Chicago Radio Show November 17th to 22nd"

New Radio Static Filter

Increases Volume
Decreases Interference

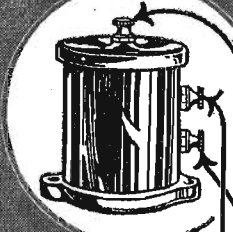

Easily Attached

This new radio invention actually separates radio tones from static, clearing reception by detouring static.

Study the diagram shown at the side of this ad. It shows where the static and radio tones enter the Filter together. Inside the Filter, the static and radio tones are separated, the static being detoured to the ground through the "A" Storage battery. But the radio tone waves are filtered through entering the set purified, clearer and increased in volume.

Attach the Filter to any set—no matter what kind—note the reception—cut out the Filter—note the difference.

With the "A B C" Filter attached to your set, you hear music as it is really played by the artists—you hear the dramatic climaxes of speeches—you understand the market reports and other announcements. Distant stations are brought in easier, due to the increased volume.

Lightning Proves Claims

We have on file a sworn statement by a Stockton, Illinois, business man. Lightning struck his building and was carried by a radio aerial to a set equipped with the "A B C" Filter. The lightning was carried through the Filter to the ground with absolutely no injury to the tubes, batteries, tuning unit or cabinet. The building was unharmed. The Filter is a perfect lightning arrester. If it will detour lightning—it will detour static. Write for a copy of the sworn statement. In event your dealer cannot supply you with the "A B C" Filter, simply mail us \$5 00, and we will send one direct with full instructions for attaching. Full guarantee with each Filter.

Static and radio tones enter Filter here, coming direct from aerial.

Static or lightning detoured here through the "A" Storage Battery to the ground.

Radio tone waves leave Filter here, purified, clearer and in greatly increased volume.

DEALERS

If you have a store or business of your own and are prepared to work cooperatively with aggressive sales and advertising help, write us today for full particulars about our proposition to dealers. We are desirous of forming connections with responsible dealers interested in selling a product of real merit, and the "A B C" has demonstrated itself to be this.

THE FREEPORT RADIO CORPORATION

Manufacturers "A B C" Static Filter. (Patent Pending)
11-15 West Stephenson Street Freeport, Illinois, U. S. A.

Sold On Money Back Guarantee

'Traveler' Doughnut Coil Tuned R.F. Receiver

Part III—Complete Wiring Instructions

By John G. Ryan

WIRING this set is remarkably easy. The reader should have no difficulty at this stage of the construction. Only two points could be called even moderately hard to get at, and the builder will have smooth sailing with the set finished surprisingly soon.

Each operation which consists of putting in a wire, is given a number which applies, after that, to the wire inserted. The first seventeen wires are put on the sub base before it is attached to the front panel. These will be described first.

Wiring the Sub Base

1. Put in a long wire from front left terminal of socket 1 to front left on socket 5 beneath the sub base with short wires branching off to front left terminals on sockets 2 and 3 and the front right on socket 4.

2. Connect front right terminals of sockets 1 and 2 with wire beneath sub base.

3. Connect right end terminal of rear Amperite to left front terminal socket 4 below sub base.

4. Connect G terminal of Thorola T-2 to front terminal of Bradleyleak (above sub base).

5. Rear terminal of Bradleyleak to be connected to rear left terminal of socket 3.

6. Above sub base, connect rear right post on socket 3 to front right post on transformer 1 (the transformer at the left).

7. Above the sub base, connect rear right post on transformer 1 to rear left post on socket 4.

8. Rear right post on transformer 2 connects to rear right post of socket 5 (above sub base).

9. Connect rear left posts on transformers 1 and 2 by wire passing under sub base.

10. Connect rear left post on transformer 1 to minus C binding post, passing under sub base.

11. Connect A terminal on Thorola T-2 with wire 1, through sub base.

12. A short lead is put in connecting rear right post on socket 1 with P on Thorola T-1.

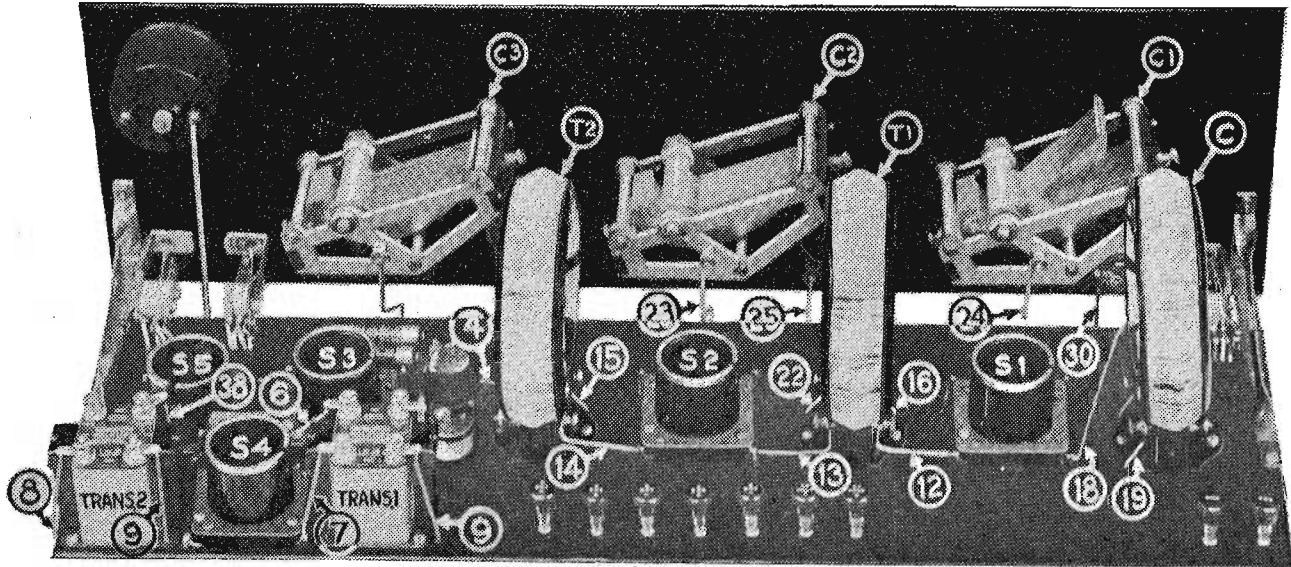

Figure 8

13. Now a wire from G on Thorola T-1 to rear left post on socket 2.

14. This series of above sub base wires is completed by connecting rear right post on socket 2 with P terminal on Thorola T-2.

15. Bend a wire so that it passes through sub base from B terminal on Thorola T-2 under the hole beneath terminal B on Thorola T-1, and then back to plus 90 binding post.

16. Put a wire through sub base from B terminal on Thorola T-1 to wire 15 just inserted.

17. Put a wire through sub base from B post on transformer 1 (front left corner) and over to plus 45 binding post.

These are all the wires that can be connected without combining panel and sub base, so with the brackets, carefully bolt these two assemblies together, taking care not to injure or bump any of the pieces of apparatus while doing so. With

the two fastened together we can proceed with the wiring.

Connecting Panel to Sub Base.

18. Considering now the jack in lower left corner of panel, connect the shorter of the two long springs to stator terminal of first variable condenser and to rear left post on socket 1. This wire is to pass above sub base. The stator terminal is almost directly above jack on upper end of condenser.

19. The spring next to that just connected is to be wired to G terminal on Thorola C by a wire passing below sub base.

20. Now bend a wire to pass from the remaining short straight spring, under the hole beneath GN on Thorola C, back to GND (ground) binding post. A short wire is dropped from terminal GN through sub base to this wire just inserted.

21. A comparatively long wire is now bent to connect long spring on jack, through sub base and across to the left end of the front Amperite.

22. Put a wire through sub base from A terminal on Thorola T-1 to wire 21.

23. Bend a wire to pass from rotor terminal of center variable condenser, in front of sub base and back under it to wire 21.

24. Another wire is bent the same shape to connect rotor of left hand variable condenser to wire 21.

25. There are two rheostats; that to the left being R-2, the other being R-3. Connect the right terminal of R-2 to wire 21.

26. Connect left terminal of R-3 to wire 21.

27. Insert a wire connecting the left terminal on R-2 with wire 2, that which

(Continued on page 20)

Building a Super?

Ryan's Simplest Possible Super-het Manual

50¢

Full Size Drilling Templates-Loop Aerial Construction

ANYONE who has built a crystal set or single-tube can follow Mr. Ryan's concise, simply worded instructions and enjoy the range available only from a super-heterodyne. Every wire, every lug, is placed by his directions and you cannot go wrong.

The construction of loop aerials, storage "B" batteries, a charger and even the cabinet are gone into thoroughly. This manual covers the complete installation of a selective, quiet, long range Radio outfit. Send money order, stamps or currency to

Radio Digest Publications
510 N. Dearborn St., Chicago

Used by John G. Ryan in the "Simplest Possible" Super

ONLY
\$22⁵⁰
BY MAIL



Qualitone Super Kit

USING the Qualitone Kit in the Simplest Possible Super-heterodyne described in Radio Digest, makes unnecessary any changes in the diagram and insures perfect operation on completion of the wiring. Each part fits into place as shown in Mr. Ryan's layouts.

Kit includes three long wave transformers, one filter coupler and one oscillator coupler, with complete set of blueprint instructions, all packed in sturdy SEALED carton. Genuine Bakelite and silk covered wire employed throughout.

Mail orders filled promptly on receipt of check or money order.

Can be used in 7 or 8 tube supers and the Heteroflex described in Radio Digest of August 1st.

QUALITONE RADIO CORP.
4600 LINCOLN AVE. CHICAGO, ILL.

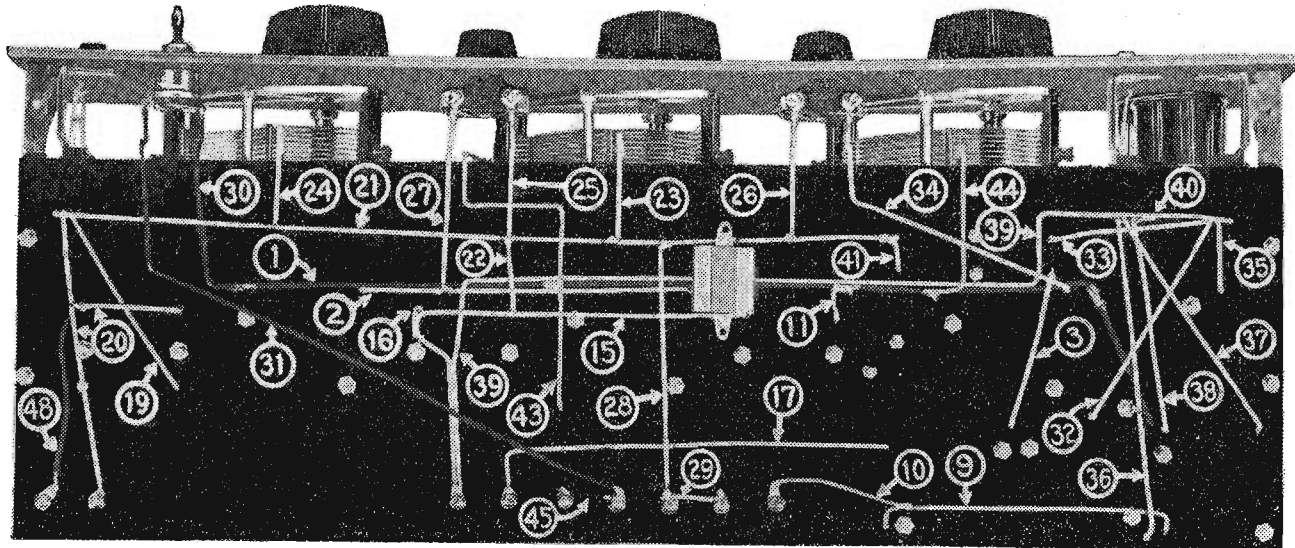

Figure 9

“TRAVELER” RECEIVER

(Continued from page 19)

connects the front right terminals of sockets 1 and 2.

28. Run a wire straight back from wire 21 to the minus A binding post.

29. Connect plus C binding post with short one-inch wire to minus A binding post.

30. Now connect the right hand terminal on the filament switch to the nearest point of wire 1, the first one put in.

31. A wire is now inserted diagonally from left terminal on switch to plus A binding post.

32. Going now to the jack in lower right corner of panel and presuming it has been put on with frame to the right, the filament control springs are the two to the left. Connect the inner of these two springs to the rear left terminal on socket 5.

33. Connect the outer filament spring to the right end of the front Amperite.

34. A wire is to be bent to pass down in front of sub base, then under it, from right terminal of rheostat R-3 to front right terminal of socket 3.

35. Going back to the jack mentioned in operation 32, drop a wire through and under sub base from the remaining spring on jack to the front right post on socket 5.

36. The second jack from the right

has, so far, been untouched. Connect the longer of the two long springs to the rear right post of socket 4.

37. Connect the front right terminal on transformer 2 through and under sub base to the short straight spring next to that just connected by operation 36.

38. The front left terminal on transformer 2 is to be connected by a wire running through and under sub base to the remaining short straight spring.

39. Considering now, these two jacks in the lower right portion of panel, bend a wire to pass from the frame terminal of the end jack beneath the remaining spring terminal of the other jack, then across sub base and close to wire 1, until opposite plus 90 binding post, then straight back to that post.

40. From the shorter of the two long springs in left hand jack (referred to as “the remaining spring terminal” in operation 39) put a wire through sub base to wire 39.

41. Drop a wire through sub base from left terminal on rear Amperite to wire 21.

42. Run a wire down and straight back, above sub base, from the stator of right variable condenser to the wire con-

necting G of Thorola T-2 with the front end of the Bradley leak (wire 4).

43. The next wire, from the stator of center variable condenser, drops straight down and then back, either above or below sub base to rear left terminal of socket 2. If run below it will be necessary to drill small hole beside rear left terminal of socket 2.

44. Bend and insert a wire to reach from rotor of right hand variable condenser (C-3), in front of, then back under sub base, to wire 1.

45. On under side of sub base, connect minus B binding post to plus A post with a short wire.

46. On under side of sub base it will be found that wires 1 and 15 are separated by a distance approximately the length of the Erla .005 mfd. fixed condenser which is to be connected across from one to the other.

47. The Erla .001 mfd. fixed con-

denser is placed on the front of socket 4, with one long side down resting on the base part of socket. In this position it will be found that the left terminal touches wire 6 while the right end is directly above the front right post on socket 4. Solder to wire 6 and drop a short wire connecting right terminal to front right terminal on socket 4.

48. A piece of flexible wire is now connected to the Antenna binding post, beneath sub base, cut to the proper length that it can be brought up through the holes beneath terminals A-1 and A-2 on the left side of Thorola C and reach either of them.

(This completes the wiring on Traveler and, if the builder is more or less familiar with Radio set operation and connecting receivers to batteries, he can proceed to try out the set. The novice, however, should wait for next week's final article on this subject.—Editor's Note.)

To Hold Head Set Adjustment

Having some trouble in keeping phones adjusted to my ears on account of the phones sliding down, I devised the little arrangement shown which seems to solve this perfectly. A piece of spring brass

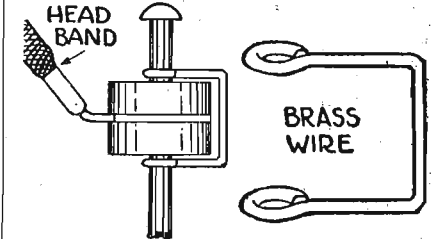

wire is used, about number 16, 18 or 20 in size. A loop is bent around the stem of the earphone, then the wire is lead out to one side of the block through which the stem passes, then to the other side of block and around stem.—O. Mulvey, Rogers, Ark.

WE SOLD 4000 SETS
Had 4000 Favorable Reports
Before We Felt Justified to Say

Quality Radio Apparatus

Now we invite you to go to your Apex Dealer who will be glad to make a personal demonstration for you in your home or in his store. A demonstration will prove to you that Apex Radio Receivers will give you everything you can possibly wish for in a radio receiver from the standpoint of selectivity, clarity, volume, distance and attractiveness of design.

The APEX Super Five without accessories...	\$95
The APEX De Luxe without accessories...	135
The APXE Baby Grand Console without accessories...	225
The APEX Utility Radio Table...	75
The APEX Entertainer (Loud Speaker)...	22.50
The APEX Console Entertainer...	27.50

Upon request we will gladly mail you descriptive folder.

APEX ELECTRIC MFG. CO.
1410 W. 59th St., Dept. 1005A
CHICAGO

Prices West of Rockies slightly higher. Canadian prices approximately 40% higher

Uniformity Guaranteed!

LEADING builders of fine sets use more Thordarsons than all competitive transformers combined because Thordarsons run absolutely alike, absolutely uniform; always “match up” perfectly; always amplify evenly. A prominent set maker recently stated: “Any radio manufacturer who is sincerely desirous of producing an instrument of the volume necessary and of a tone superior to anything else on the market, must be absolutely forced to use Thordarson transformers sooner or later.” Follow the lead of the leaders—build or replace with Thordarsons. Unconditionally guaranteed. Any store can supply you. Thordarson Electric Mfg. Co., Chicago.

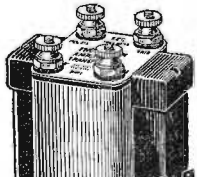

THORDARSON
Super
AMPLIFYING TRANSFORMERS
Standard on the majority of quality sets

ZENITH
KENNEDY
Radiodyne
Planstiehl
Howard
Thermodyne
GLOBE
Deresnadyne
ADLER-ROYAL
MURDOCK
MU-RAD
Valley
Silver-Marshall
OZARK
ULTRADYNE
Newport
LEICH
NUNN-LANDON
KUSTOMBILT and many others

Also choice of the MacMillan Arctic Exposition

Vigilance
Constant vigilance is the price of uniformity and constant vigilance is maintained over Magnatrons. That is why Magnatrons are uniform, and uniformly good.

The Magnatron DC-201A, DC-199, and DC-199 (large base) now list for only \$2.50 each.

CONNWEY ELECTRIC LABORATORIES
Magnatron Building Hoboken, N. J.

MAGNATRONS

MAGNATRON REX the new tube for D battery eliminators

Send for this **RADIO BOOK FREE** 1926 Catalog of **Everything New in RADIO** at a Big Saving in Price

The World's Largest Exclusive Radio Mail Order House Will Send You This Wonderful Book FREE

64 illustrated pages containing thousands of bargains in radio sets, semi-finished sets and radio kits of all styles, sizes and approved circuits. Beautiful models of the very latest designs and types. Elaborate console models with loud speakers built right into cabinets of genuine mahogany and walnut. ALL SETS GUARANTEED.

Our line includes all popular sets, such as **Superheterodyne, Neutrodyne, Ultradyne, Reinartz, Regenerative, Radio Frequency, Browning-Drake, Reflex** and all other latest circuits. Kits, sets and parts manufactured by all well known manufacturers, such as: Frost, Howard, Baldwin, Brandes, Western Electric, Columbia and others.

Our Guarantee
Every article exactly as represented. Every article is tested before shipping. Complete satisfaction or money cheerfully refunded.

Don't Buy Anything in Radio Until You Get Our Big Money Saving Catalog
RANDOLPH RADIO CORPORATION
The Largest Exclusive Radio Mail Order House in the World
159 N. Union Ave., Dept. 25, Chicago, Ill.

Our Catalog
includes complete list of broadcasting stations and general information and facts about our free service division. Our radio engineers will help you solve all your radio problems. Send your name and address on a card or in a letter. We will send catalog FREE.

A. B. C. Course in Radio Fundamentals

Chapter XXXI—Modulation in Radiotelephony (Conclusion)

By David Penn Moreton

IN UNDAMPED wave Radiotelegraphy, the transmitting circuit radiates energy continuously, when the transmitting key is closed, at a constant and uniform rate, as a result of the constant amplitude of the alternating current in the transmitting antenna. After a simple rectification in the receiving station there is an unvarying direct current produced, which simply deflects the diaphragm of the telephone receiver, without setting it into vibration, and therefore, without producing any sound.

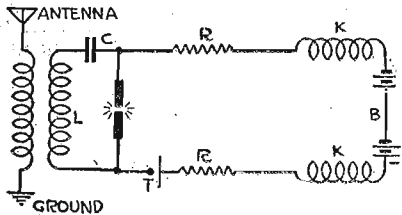

Figure 125

If the amount of energy radiated by the transmitting antenna is varied, for example, by varying the maximum amplitude of the alternating current flowing in the antenna circuit, a corresponding varying or pulsating direct current will be produced in the plate circuit of a rectifying tube having a telephone receiver in circuit. If these variations in the antenna current at the transmitting station are of audio frequency, such as those produced by a telephone transmitter actuated by the voice, a sound having the same frequency and characteristics as the variations of the transmitted energy will be produced in the telephone receivers of the Radio receiving circuit, thus enabling the reproduction at the receiving station, under suitable conditions, of the sound producing these variations at the transmitting station.

A Radiotelephone transmitting circuit consists of a radiating or antenna circuit in which oscillations are set up by a generator of undamped oscillations, and an arrangement of circuits whereby the amplitude of these oscillations may be varied or modulated by the human voice vibrations. The common methods for generating undamped oscillations are the arc, the alternator and the three electrode vacuum tube.

A Radiotelephone receiving circuit is essentially the same as a damped wave Radiotelegraph receiving circuit and comprises a tuned antenna circuit, coupled or connected to a rectifying detector and telephone receiver circuit and such other auxiliary tuned and amplifier circuits as may be required.

In general, the methods of modulating the high frequency alternating current flowing in the transmitting antenna may be divided into two general classes: namely, direct current modulation and high frequency modulation. For example, in the oscillating arc, direct current is fed into the arc and alternating current is obtained in the output oscillatory shunt circuit. In the high frequency alternator, direct current is sent into the field winding, and alternating current is obtained in the output or alternating current armature circuit. In the three electrode vacuum tube, it is the energy furnished

by the plate battery which is transformed into alternating current. In all three cases the alternating current power output is, at least within limits, proportional to the amount of direct current input.

Methods of Modulation.

One method of varying the amplitude of the generated high frequency alternating current is, therefore, to vary or modulate the direct current input before its transformation into alternating current. The other method is direct modulation of the alternating current output.

The first step in the process of modulation is the transforming of the sound vibrations due to the voice into variations of the electric current in the transmitting circuit, proportional in amplitude to the sound vibrations, and of the same frequency and wave shape. This transformation is generally accomplished by means of the ordinary carbon microphone or telephone transmitter although special transmitters have been built in order to overcome certain practical difficulties. One method makes use of a condenser type of transmitter.

For the most effective modulation, the transmitted energy must be modulated or controlled over a larger part of its maximum or steady value. For example, the best modulation will be that for which the transmitted energy may be made to vary all the way from its maximum or steady value to zero. Unless the distance is very short, the amount of power to be controlled is of the order of several kilowatts. In view of the fact that the amount of power represented in the sound waves is so very small, it is evident that some means must be used to amplify their effect before this effect can be used in modulating the high power output of the station.

Three methods have been used to accomplish this purpose and they are usually designated as the microphone method of control, the vacuum tube method of control and the ferromagnetic method. The first of these methods has practically become obsolete since the introduction of the last two. The last method is particularly useful in handling large amounts of power, while the second, although applicable to high power control, is economically used on low and medium power sets only. Combinations of the last two methods are sometimes used giving a very efficient and flexible method of modulation.

The microphonic methods of control or modulation of the transmitted energy were probably the earliest methods used. They were employed principally in conjunction with circuits having an oscillating arc as the source of undamped oscillations.

The ordinary telephone transmitter will work satisfactorily at a current of not more than about two amperes and handle a maximum power of about two watts, so that at first a number of transmitters were connected in parallel in order to control a large amount of power. The transmitters were all mechanically and acoustically connected to a single mouthpiece into which the operator talked. This method of modulating the radiated energy, although apparently simple in principle, is not satisfactory. In general the various

transmitters are of different resistances, which results in an uneven distribution of the current among them and produces excessive overloading and consequent heating of some of them. The microphones of transmitters may not have identically the same period of vibration, inertia, and modulation characteristics, so that the voice vibrations are not reproduced synchronously nor identically in the various transmitters, the result being a distorted modulation of the radiated energy.

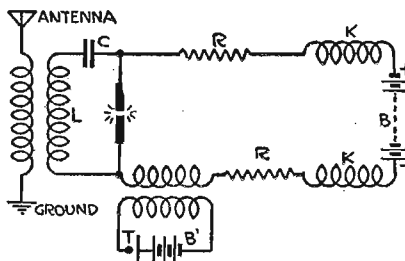

Figure 126

Attempts have been made to build a single microphone capable of carrying heavy currents, and provided with water or oil cooling systems, or in which the carbon granules were kept in constant motion or change continuously. Microphones were tried in which the resistance was no longer varied by a carbon contact, but by the variable volume of a water jet. All of these various schemes, although more or less satisfactory in operation, are as a rule quite clumsy and, in reality, little better than makeshifts.

These methods of control are discussed briefly, in order to familiarize the reader with the history of the methods of modulation of transmitted energy. The circuits show a single transmitter or microphone for modulation.

Two direct current methods of modulation are shown in figures 125 and 126. These show an electric arc connected for the generation of high frequency oscillations and coupled to a tuned antenna circuit. The arc is supplied with direct current from the battery B with the choke coils K and stabilizing resistances R in series. The microphone T is either connected directly in series with current supply to the arc as shown in figure 125 or coupled to this circuit as shown in figure 126. The resistance of the transmitter is varied at audio frequency by the operator's voice which produces two simultaneous effects. Due to the variation in the resistance of the transmitter, there is a variable amount of direct current power fed into the arc to be transformed into alternating current. Also due to the variation in the potential drop across the transmitter a varying potential is impressed across the arc, with a cor-

responding variation of the position of the direct current operating point of the arc along its static characteristic curve. These effects combine to produce variations of modulations of the high frequency output of the arc, and, therefore, of the radiated energy.

The frequency of the oscillations set up by the arc in the oscillation circuit may be considered roughly to be constant, and it is determined by the constants of the oscillatory circuit. The effect of modulation is to vary the amplitude of these oscillations. The frequency of the variations due to modulation are of audio frequency and produce in the plate circuit of the receiving detector a variable direct current which actuates the diaphragm of the telephone receiver.

(CONCLUSION)

Audio Transformer Test

Connect one tip of a pair of phones to the 16½-volt terminal of a 22½-volt B battery, connect the 22½-volt terminal to a piece of insulated wire. Without touching the bare wire with the hand hold it against the case of the transformer, being sure to make contact with bare metal. Touch free tip of the head phones to the terminals on that side of the transformer to which the wire is connected. Repeat on the other side of the transformer. A click indicates that the terminal to which the connection is made is grounded to the frame.

Flat coils are often space savers when building a set.

The Wilson "B" Radiopower Unit

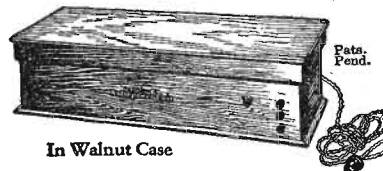

In Walnut Case

Operates from light socket. Supplies the uniform voltage necessary for perfect reception. Absolutely noiseless. Guaranteed not to set up the slightest hum. No acid to spill. No moving parts to get out of order. Requires no attention. As easy to operate as switching on a light. Convenient and dependable. The least expensive plate current supply because of its long life. In handsome walnut case. Price complete, \$35. Your dealer can supply you.

The Andrews Paddlewheel Coil

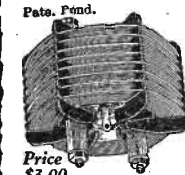

Price \$3.00

Improves tone quality. Increases selectivity, range and volume. Losses are negligible. Has exceptionally high ratio of inductance to resistance with minimum distributed capacity.

Used in well-known receivers such as the Deresmadyne and Buckingham. Can be used in any standard hook-up. Ask your dealer for blue-prints of circuits employing this coil.

Our Technical Dept. will answer inquiries.

Duo-Spiral Folding Loop

Highly directional and very selective. Reduces static and helps to cut out interfering stations.

Price \$8.50

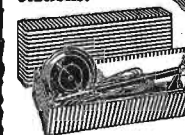

Handsomely finished in silver and mahogany. Easily portable. Has long handle and graduated dial. A special model for every circuit.

See these standard units at your dealer's or write for complete information.

Radio Units Inc.

Maywood, Illinois
1306 First Avenue
Perkins Elect. Ltd., Montreal, Toronto, Winnipeg

TELEVOCAL QUALITY TUBES

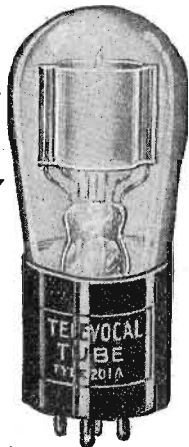

A Technical Triumph Fully Guaranteed

TELEVOCAL CORP'N
67-A Fifth Ave. NEW YORK

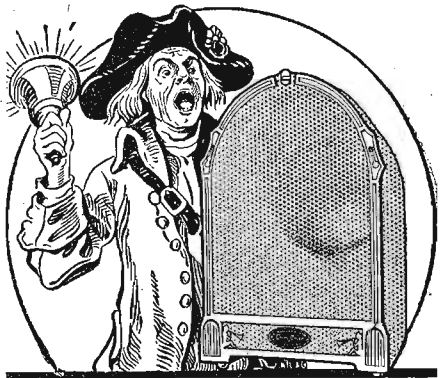

The TOWN CRIER Radio's Most Beautiful Speaker

WRITE today for illustrated description in colors of this beautiful instrument—"The Speaker with the Voice that Thrills." You will be delighted with the artistic stippled finish and the gorgeous colors of the Town Crier models in Green and Golden Polychrome. Ask your Dealer to show you a Town Crier—you will recognize its surpassing excellence instantly.

PRICE \$17.50 \$18.50
West of the Rockies
GALE RADIO LABS.
2513 Irving Park Blvd. CHICAGO

Make \$100 Weekly—I Will Show You How!



J. Matheson Bell, Pres., Ozarka Inc.

YOU can do it in your spare time—evenings. Lay the foundation for a permanent, profitable business of your own. Give it all your time when you've proven the big opportunities it holds for you. Sell what the public wants—

Sell Radio In Spare Time!

Demonstrate the Ozarka in your own home or in your prospect's home. Sales experience not necessary—we teach you! Ozarka instruments priced right, with sales help, national and local advertising, make your selling easy.

12 Selling Lessons FREE!

The Ozarka plan of selling radio is entirely different. Most practical—easier to explain. Sales are made quicker and easier. Knowledge of radio not necessary—we teach you every detail without charge! Our success with 8,100 men proves the merit of our teaching.

3,100 Men Are Doing It!

The Ozarka organization today consists of 3,100 men. In territory not now covered the right man is wanted. \$100 weekly in spare time is not unusual. Many Ozarka men are making far more—some have been with us for three years.

FREE Book Tells How—

Write me personally—tell me about yourself, and I'll see that my 64 page book, Ozarka Plan No. 100, is sent you without cost. Please mention the name of your county. To be sure of my personal attention, attach coupon below to your letter.

OZARKA INCORPORATED
122 Austin Avenue C. Chicago, Illinois
Gentlemen: 9-25-122C

I am greatly interested in the FREE BOOK "The Ozarka Plan" whereby I can sell your radio instruments.

Name.....
Address.....City.....
County.....State.....

Questions and Answers

Gears for Condenser Operation

(14605) WGM, Whitewater, Wis.
Referring to the August 22 issue of Radio Digest, page 19, figure 3, I am very much interested in the way you show to connect two or more condensers together to make a single control set. Can you advise me where I can obtain the miter gears, hard rubber bushing connectors and necessary bearings?

A.—We wish to advise that the gears under discussion may be secured from the Boston Gear Works Sales company, 955 Washington Blvd., Chicago. For the hard rubber bushing connectors, secure hard rubber tubing of the correct inside diameter from the Chicago Salvage Stock company, S. State St., Chicago, and then drill and tap for set screws. The bearings can well be made from the bushings of switch blades.

The Prize Winning Set

(14551) JEM, Piru, Calif.
Your readers expected that you would publish the details of the set which won first prize in the gold set award contest you conducted some months ago. Then recently it was announced that a series of articles on the construction of Mr. Sheldon's set would be run. This material has not appeared and I would like to know if there is someone I can write to, to get some details of this outfit.

A.—There was some delay during the first few months after the contest in getting suitable articles by the winner of the contest. Then, as we were about to publish the series, an element entered the proposition that was not in accordance with our policies of publishing that made our running the series impossible. You can get full information on this set by writing to C. C. Sheldon, D street, LaVerne, California, who has now gone into business constructing these sets as The Sheldon Radio Co.

Roberts Knockout

(14606) LHM, Tulsa, Okla.
Please send me the issue of your paper that had the diagram and parts necessary for the Roberts circuit which has been explained to me as a banner receiving set. At the same time please advise the yearly subscription price to your paper.

A.—We have not published data on the Roberts Knockout Series of receivers. This circuit is featured by the monthly contemporary Radio Broadcast, Garden City, New York. If you will write to Arthur H. Lynch, editor of that publication, he will advise you as to cost of either back issues or blueprints. The subscription price to Radio Digest is \$5.00 per year.

Short Wave Receiver

(14609) HND, Richmond, Tex.
Will you please advise me where I can get the data for a reliable short wave receiver, parts necessary to construct and any other helpful information you may have? Would like to get this as soon as possible.

A.—Pamphlets have recently been prepared, and are being mailed to those requesting them, by the Zenith Radio corporation, Straus Bldg., Chicago, and by the Burgess Battery company, Madison, Wis. That described in the Zenith bul-

Fullman conductors, porters, men wishing such positions can easily qualify, information free. Supt., 123C Railway Exchange, Kansas City.

Manufacturer of new and improved station-finder and vernier tuning-dial wants live salesmen calling on radio trade. Excellent side-line; good commission; exclusive territories. Westerland Corp., Dobbs Ferry, N. Y.

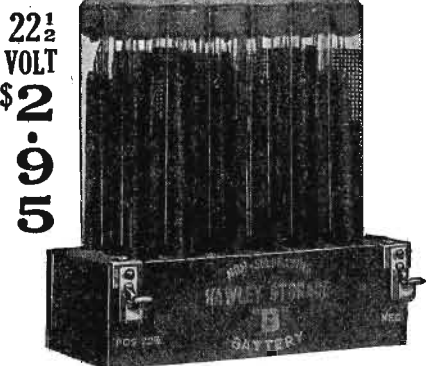

It's OUT—Complete everlasting ready to run non-acid, non-sulphating 22½-volt rechargable "B" storage battery, \$2.95. Includes chemical. Does not lose its charge standing idle. Special 2-22½ volts (45 volts) \$5.25; 90 volts \$10.00; 112½ volts \$12.50; 135 volts \$14.75; 157½ volts \$16.80. Nearly 3 years sold on a non-red tape, 30-day trial offer, with complete refund if not thoroughly satisfied. Further guaranteed 2 years. Knock-down kits at still greater savings. Complete ready to run "B" battery charger \$2.75. Sample cell 35c. Order direct—send no money—simply pay expressman its cost on delivery, or write for my free literature, testimonials and guarantee. Same day shipments. My large 36-page radio goods catalogue 10c. B. D. Smith, 31 Washington Ave., Danbury, Conn.

DIRECTIONS FOR REQUESTING INFORMATION

The Questions and Answers department offers service to Radio Digest subscribers without charge and, to those not subscribers, the same service with a charge of 50c for each letter requiring up to three answers or diagrams. We feel that this policy is necessary for the protection and best interests of our regular readers, as the volume of correspondence to this department has increased to such an extent that it is almost impossible to give our subscribers' letters adequate attention nor a complete answer. To those who have long been newsstand readers this may, at first, seem an injustice but a little thought on the matter will show that this is the only possible solution of what has been, to the technical department, a very perplexing and difficult problem. We ask that the following suggestions be read carefully before writing:

- 1—Search carefully the back issues which you have, as the point in question has probably been covered several times before.
- 2—The book, "Radio Receivers," given free with each yearly subscription, contains the answers to the majority of the questions asked. If you have this book, go through it thoroughly and it is probable that you will find the solution of your problem.
- 3—Letters for this department should be kept separate from all correspondence to other departments and on other subjects.
- 4—Questions should be written on one side of paper only and each sheet should bear the sender's name and address. All letters should be accompanied by a self-addressed stamped envelope of standard business size.
- 5—Unsigned (or anonymous) letters cannot be answered, either on this page or by letter, nor can those without address.
- 6—No comparative statements on advertised apparatus will be given except as to efficiency in some particular circuit.
- 7—Drawing diagrams on a separate sheet of paper will save time and enable us to give all questions more attention.
- 8—Write each question as a separate paragraph.
- 9—Keep a copy of your letter and diagrams, to which we can refer without re-drawing.
- 10—The names and addresses of the writers of letters published will not be released except with the writer's permission.
- 11—We want to be of assistance to you in your difficulties, but are sometimes limited because of the length and time required for the proper consideration of the questions asked. Therefore, please make your letters brief.

letin was designed by John Reinartz while that described by Burgess is a result of their laboratory experiments.

Building Four Tube Set

(14567) LS, Elgin, Ill.
Please send me a circuit for a good four tube receiver giving one stage of tuned radio frequency detector and two stages of audio amplification, not reflexed.
A.—We can give you your choice of two good circuits. An excellent tuned bridge radio frequency hook-up was given by Milo Gurney in our issue of July 4, and constructional data appeared in the issues of July 11 and 18. Another bridge cir-

cuit, of the impedance coupled type, was presented by R. N. Skeeters in our issue of August 15. If you do not have these back numbers they can be had by sending ten cents in coin or stamps for each issue.

A good sized screw driver, if magnetized will pick up steel screws that have been dropped in places you cannot reach with fingers or pliers.

25 RADIO STAMPS FREE
With World Radio Stamp Album and Log. Contains ruled spaces for stamps of stations in U. S., Canada, Europe, etc. Stick stamps in proper spaces as stations are heard. Also contains convenient Log and complete list of stations, call letters, wave lengths, etc. Send 35c for Album and get 25 genuine radio stamps FREE. Get more pleasure out of your radio. Order NOW.
WORLD TRADING CO., Dept. 8417, 366 Wrigley Bldg., Chicago

condensers 75c. Surplus stock, high grade vernier and plain variable condensers, all sizes. While they last, 75c. Good three-inch dials 15c. Satisfaction guaranteed or money refunded. Order immediately, first come first served. Radio Supply Company, Bluffton, Ohio.

GO into the RADIO BUSINESS
We specialize in Equipping New Dealers with entire stock—advice free.
Send for Our Radio CATALOG & BARGAIN LISTS
Wholesale Only
MANHATTAN RADIO COMPANY
112 Trinity Place New York City

COMPLETE 500 WATT TRANSMITTER FOR SALE CHEAP

A transmitter favorably known from Coast to Coast and from Alaska to South America. Built by one of the country's foremost Radio Engineers.

Southern Equipment Company
San Antonio, Texas

PATENT ATTORNEYS
PATENTS. Booklet free. Highest references. Best results. WATSON E. COLEMAN, Patent Lawyer, 644 G Street, Washington, D. C.

25 RADIO STAMPS FREE
With World Radio Stamp Album and Log. Contains ruled spaces for stamps of stations in U. S., Canada, Europe, etc. Stick stamps in proper spaces as stations are heard. Also contains convenient Log and complete list of stations, call letters, wave lengths, etc. Send 35c for Album and get 25 genuine radio stamps FREE. Get more pleasure out of your radio. Order NOW.
WORLD TRADING CO., Dept. 8417, 366 Wrigley Bldg., Chicago

THE Antennaphone
REPLACES THE AERIAL
IMPROVES RECEPTION
Gives wonderful results with any radio set. Not attached to, but merely placed under the telephone. Price One Dollar. Complete with insulated wire and simple instructions. At Your Dealer or Mailed C.O.D. on 3 days approval.
ANTENNAPHONE CO.
90 West St. New York City

Steinite LOW Interference Eliminator

No Radio Set Complete Without It

Now you can select stations at will, cut out interference and undesired stations—tune in loud and clear. Wonderful results with any tube or crystal set using any kind of aerial except loop antenna. Partially absorbs static.

Amazing Results, Better Reception Guaranteed or We Refund Your Post-Dollar. Send paid. Order Today

Select Stations At Will

Try this Interference Eliminator on your set—no tools—nothing to add—attached in 2 minutes to aerial. Doesn't disturb present log. Directions easy to follow. Two big banks testify to our reliability. Order today—dollar bill will do—we take the risk—money back if you say so.

STEINITE LABORATORIES
Dept. 303 Radio Building, ATCHISON, KANSAS
Write for complete Steinite Radio literature—it's FREE. Most beautiful and least expensive radio sets in America.

Electric Soldering Iron

Soldering up a Radio outfit is quite a job unless you have a good soldering iron, and nothing beats the electric type. To heat an iron in gas consumes a lot of time and for the man in a small town without gas or electricity it is a bug-a-boo. I will try and show how to make an electric iron out of a few scraps and two binding posts.

Take two pieces of brass or copper about 2" long and ¼" wide, shape and drill two holes in them as shown in figure A. Fasten each to handle made of wood, fibre or bakelite. Handle is 4½"

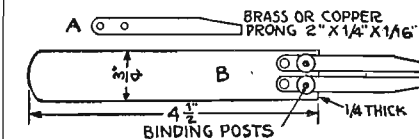

long and ¼" wide. Use one screw and one metal binding post for each prong as in second drawing. Prongs should be ½" apart.

Connect with twisted light wire to 6-volt battery. To operate, put soldering solution on joint and lay a small piece of solder on it. Touch both prongs to joint thereby causing a momentary short circuit. This will cause joint to heat and solder will flow. Current is consumed only during use.—W. C. Roy, Memphis, Tenn.

Sensational Radio Offer! Guaranteed 5-Tube Set at low price. Unique selling plan. \$50 to \$150 weekly easy. No experience required. Free outfit offer. Act quick. Zeus Radio Co., Dept. F, 440 Wrigley Bldg., Chicago.

Make \$100 WEEKLY in spare time. Sell what the public wants—long distance radio receiving sets. Two sales weekly pays \$100 profit. No big investment, no canvassing. Sharpe of Colorado made \$955 in one month. Representatives wanted at once. This plan is sweeping the country—write today before your county is gone. OZARKA, INC., 126-G, Austin Ave., Chicago.

New Perpetual LOG
Loose Leaf for Revisions—Radio Map FREE
New 64 page log. Corrected sheets may be secured as changes in calls, wave lengths, owners, etc., occur. Holds 504 stations. Shows call, city, wave lengths, 4 dial settings, remarks, etc. Tuning suggestions. Station list by wave lengths by states, etc. Owners. Trouble aids. Other valuable information. So convenient. Worth many times small cost. A joy to use. Only \$1. Pay postman after log arrives. Postpaid if pay with order. Money refunded if not delighted. Order today—now.
Radio Printers, Dept. 7997, Marengo, Ill.

Wanted—
Commercial operator for 100-watt Radio station, in town of 100,000. Regular or part time. Radio department sales work in connection with the operating. Steady employment year round. Good salary. Pleasant place to work. Advise fully about yourself in first letter.
X. Y. Z., CARE OF RADIO DIGEST
510 North Dearborn St.
CHICAGO, ILL.

FAMOUS "COAST TO COAST" MIRACO GUARANTEED
RADIO'S-Factory Prices SAVE 1/3 TO 1/2
Powerful, New Multi-tube Miraco gets long distance on loud speaker. Set, ONLY SEND for SPECIAL OFFER!
Users everywhere report Miraco radios get programs coast to coast; outperform sets 3 times as costly. Many hear foreign countries. Radio's most amazing values in guaranteed, factory tested, long distance sets—let testimony of users convince you.
(AGENTS FREE) Literature on (DEALERS) latest 1 to 6 tube models and new low prices.
Write!
MIDWEST RADIO CORPORATION
Pioneer Builders of Sets
437-A E. 8th St., Cincinnati, Ohio

325 RADIO Storage "B" Battery
32 Cells Lasts Indefinitely—Pays for Itself
Economy and performance unheard of before. Recharged at a negligible cost. Approved and listed as Standard by leading Radio Authorities, including Pop. Radio Laboratories, Pop. Sci. Inst. Standards, Radio News Lab., Letax, Inc., and other important institutions. Equipped with Solid Rubber Case, for insurance against acid and leakage. Extra heavy glass jars. Heavy, rugged plates. Order yours today!

SEND NO MONEY Just state number of batteries wanted and we will ship day order is received. Extra Offer: 4 batteries in series (36 volts), \$12.75. Pay expressman after examining batteries. 5 per cent discount for cash with order. Mail your order now!

WORLD BATTERY COMPANY
1219 So. Wabash Ave., Dept. 76 Chicago, Ill.
Makers of the Famous World Radio "A" Storage Battery
Prices: 6-volt, 100 Amp. \$11.25; 120 Amp. \$13.25; 140 Amp. \$14.00.
All equipped with Solid Rubber Case.

World STORAGE BATTERIES
Set your Radio Dials at 210 meters for the new 1000 watt World Storage Battery Station. WSSC, Chicago. Watch for announcements.
KOKA—WFAF—WGN—WJS—KHJ—KGO—KPAF—WJY—KOB